

Vestire lo spazio/

DRESSING UP YOUR SPACE

.....
MIXER WARDROBE

Alf DaFrè



Alf DaFrè

**L'armadio
come un elemento
d'architettura.
Pareti che parlano
il linguaggio
della materia.
Finiture affascinanti
e dettagli ricercati.
Volumi che si
inseriscono
in diversi spazi
della casa.**



design **ENRICO CESANA**

The wardrobe as a piece of architecture.
Walls that speak the language of different materials.
Captivating finishes and elegant details.
Shapes that fit into different spaces in the home.

El armario como elemento de arquitectura.
Paredes que hablan el lenguaje de la materia.
Acabados fascinantes y detalles elegantes.
Volúmenes que se integran en diversos espacios del hogar.

L'armoire comme un élément d'architecture.
Des parois qui parlent le langage de la matière.
Finitions pleines de charme et détails recherchés.
Des volumes qui s'insèrent dans différents espaces de la maison.

Der Schrank als Element der Architektur.
Eine Wand, die über Materie mit dem Raum kommuniziert.
Faszinierende Oberflächen und elegante Details.
Volumen, die sich in die Räume eines Zuhauses einfügen.

Шкаф как архитектурный элемент.
Стенки, говорящие языком материи.
Изумительная отделка и изысканные детали.
Объемы, заполняющие различные пространства дома.

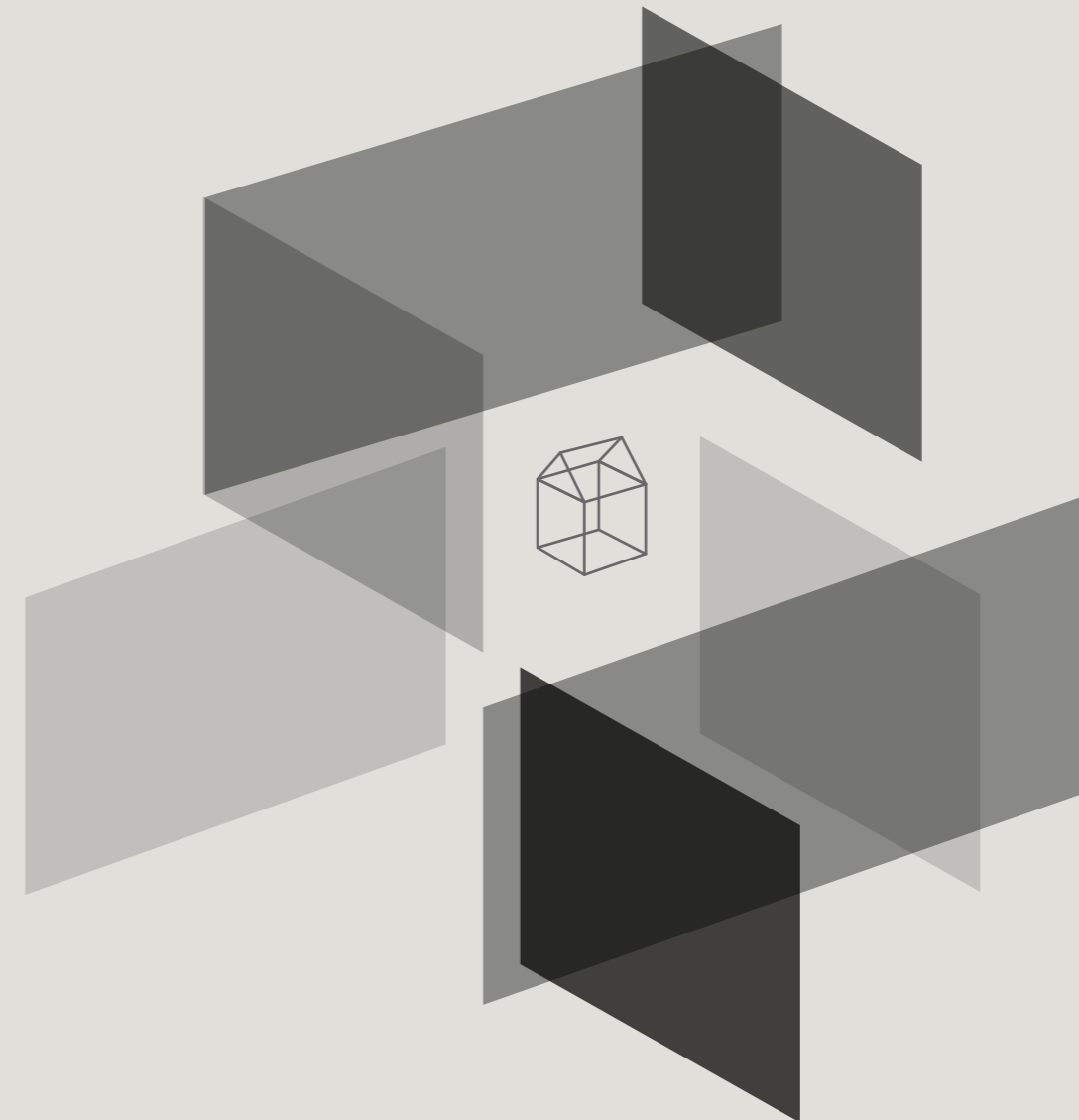

Index

BATTENTI

Swinging

- pag. 008 Simple
- pag. 014 Sliver
- pag. 020 Strip

BATTENTI / SCORREVOLI

Swinging / Sliding

- pag. 026 Display
- pag. 032 Rain
- pag. 038 Simple
- pag. 050 Split
- pag. 056 Strip

SCORREVOLI

Sliding

- pag. 062 Vision
- pag. 066 Frame
- pag. 092 Quadra
- pag. 106 Simple
- pag. 112 Rubic

COMPLANARI

Coplanar

- pag. 124 Glide



Simple p. 12



Sliver p. 18



Sliver p. 14



Strip p. 20



Simple p. 08

BATTENTI

Swinging

**Simple
Sliver
Strip**

Simple/
Un progetto
di ampie
prospettive

A project with a broad
outlook

Un proyecto de amplias
perspectivas

Un projet aux amples
perspectives

Ein Projekt mit einem
weitem Blick für den Raum

Проект с обширными
перспективами



.....
Simple battente /swinging L624,4 x 472,9 P62,4 H255,1

Fashion wood Rovere Biscotto, maniglia Pomolo pelle /
 Fashion Wood Biscotto oak, Pomolo leather handle

Ladigue divano /sofa L314 P104 H74

Jet set poltrona /armchair L77 P87 H80

Normann tavolino /occasional table L70 P120 H33,6

**Simple/
Una maniglia
caratterizzante**

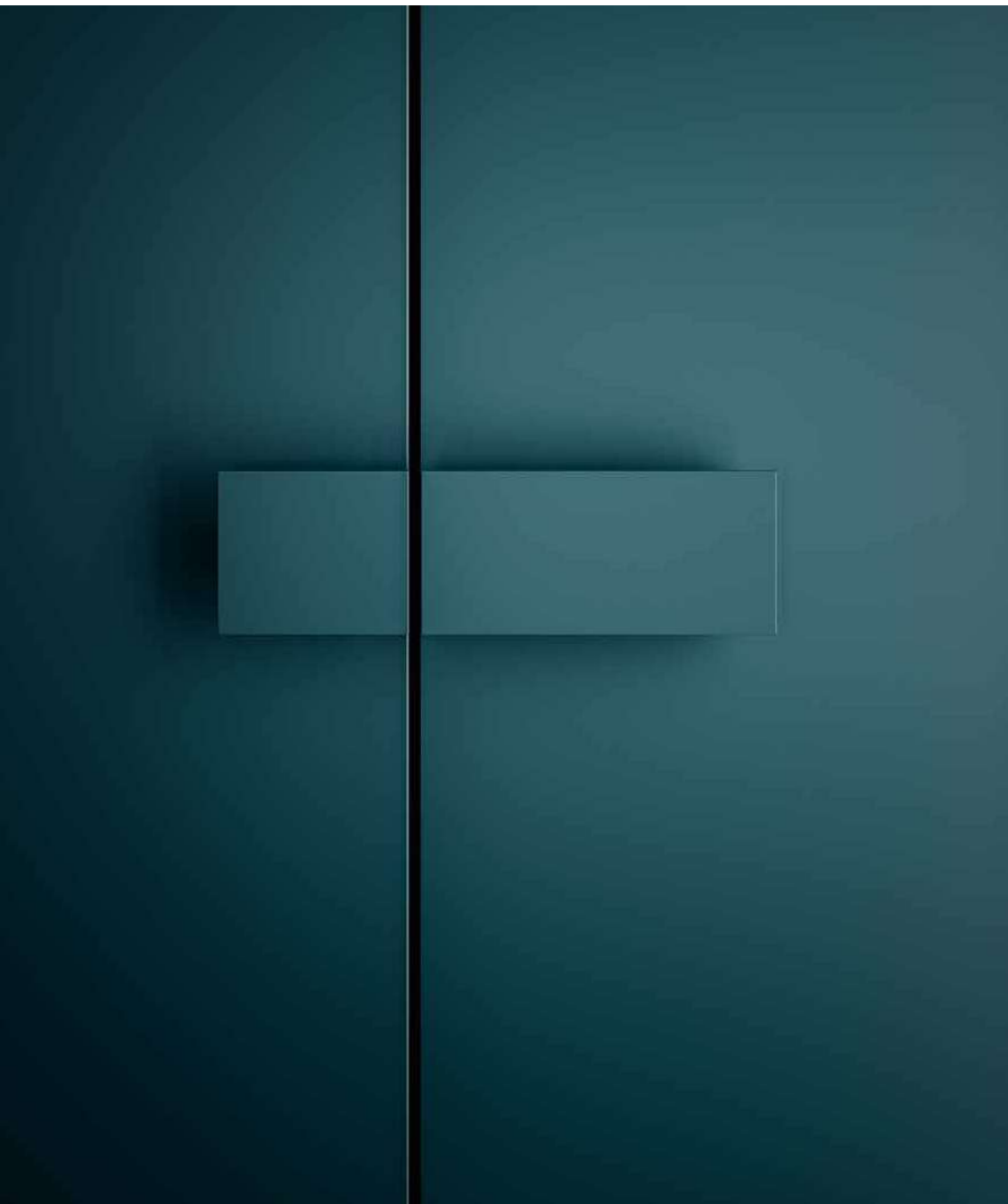

Simple battente /swinging L341,8 P62,4 H255,1

Laccato opaco Blu notte, maniglia Elios /
Matt Blu Notte lacquer, Elios handle



A feature handle

Un tirador con
personalidad

Une poignée
caractérisante

Ein Griff mit Charakter

Характерная ручка

Sliver/ Chiaro e lineare

Clear and linear
Claro y lineal
Clair et linéaire
Klar und linear
Светлый и линейный

Sliver battente /swinging L352,2 P61,6 H255,1

Laccato opaco Conchiglia / Matt Conchiglia lacquer

Wok box tavolino /occasional table Ø35 H43

Life tavolino /occasional table L55 P45 H42



**Sliver/
Il dettaglio
che fa
presa**

.....
Sliver battente /swinging L456 x 451 P61,6 H255,1
 Laccato opaco Arena / Matt Arena lacquer
Ceppo tavolino /occasional table Ø30 H47



Details that get noticed

El detalle que llega hondo

Le détail qui fait effet

Ein griffiges Detail

Деталь с функцией захвата

**Strip/
Architetture
verticali
e di forte
presenza.**

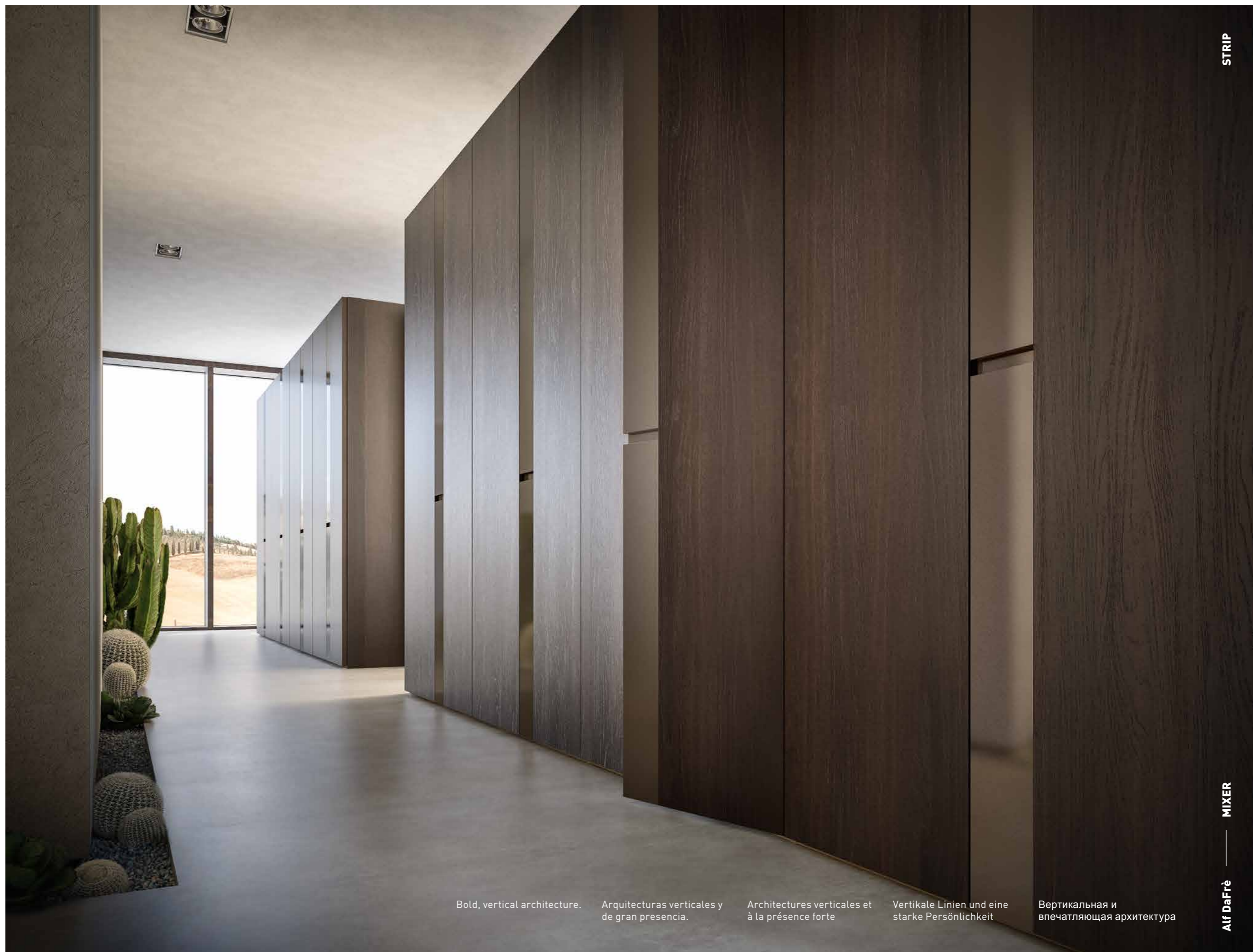

Bold, vertical architecture.

Arquitecturas verticales y de gran presencia.

Architectures verticales et à la présence forte

Vertikale Linien und eine starke Persönlichkeit

Вертикальная и впечатляющая архитектура



Strip battente /swinging L454,9 P62,4 H255,1

Fashion wood Rovere Terra, Laccato lucido Fango /
Fashion Wood Terra oak, glossy Fango lacquer

Tuft tavolino /occasional table Ø60,3 H36,8

Life tavolino /occasional table Ø46 H52





Rain p. 32



Simple p. 38



Simple p. 44



Display p. 26



Split p. 50



Strip p. 56

BATTENTI / SCORREVOLI

Swinging / Sliding

Display
Rain
Simple
Split
Strip

Display/
Il guardaroba
diventa una
boutique



The wardrobe-come-boutique

El ropero se convierte en una boutique

La garde-robe devient une boutique

Aus der Garderobe wird eine Boutique

Шкаф-купе становится бутиком







Display scorrevole /sliding L681,1 P69 H255,1

Telaio Moka shine, Vetro Trasparente grigio /
Moka Shine frame, Grigio transparent glass

Display/Sliver battente /swinging L341,8 P62,6 H255,1

Laccato opaco Conchiglia, Telaio Moka shine, Vetro Trasparente grigio /
Matt Conchiglia lacquer, Moka Shine frame, Grigio transparent glass

Xilo letto /bed L174,5 P216 H95,2

**Rain/
Le pareti
diventano
protagoniste**





The walls become the star
of the show

Las paredes se hacen
protagonistas

Les parois deviennent
protagonistes

Hier spielen die Wände die
Hauptrolle

Стенки становятся
основными элементами





Rain battente /swinging L568 P62,4 H255,1

Laccato opaco Piombo, Maniglia Timeless Moka shine /
Matt Piombo lacquer, Timeless Moka Shine handle

Rain scorrevole /sliding L341,8 P67 H255,1

Fashion wood Rovere Terra, Maniglia 3D Moka shine /
Fashion Wood Terra oak, 3D Moka Shine handle

Denny pouf /footstool Ø55/85 H42/37

Tuft tavolino /occasional table Ø40,3 H46,3

Oregon letto /bed L187 P225 H102

Twice comodino /night stand L64 P47,4 H44,4

Twice settimanale /5 drw chest L64 P47,4 H123,8

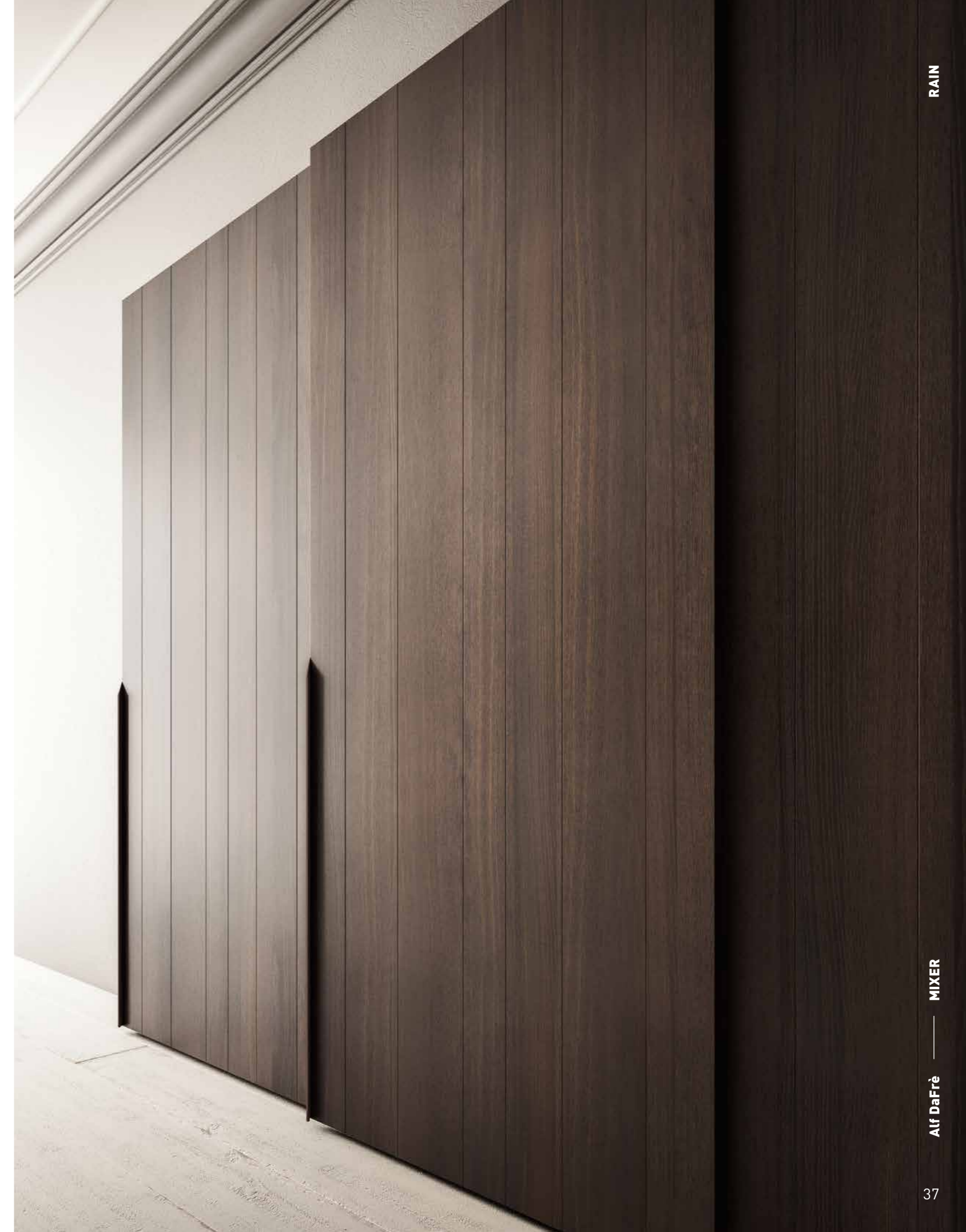

**Simple/
Armadio
angolare
con scrittoio
integrato.**



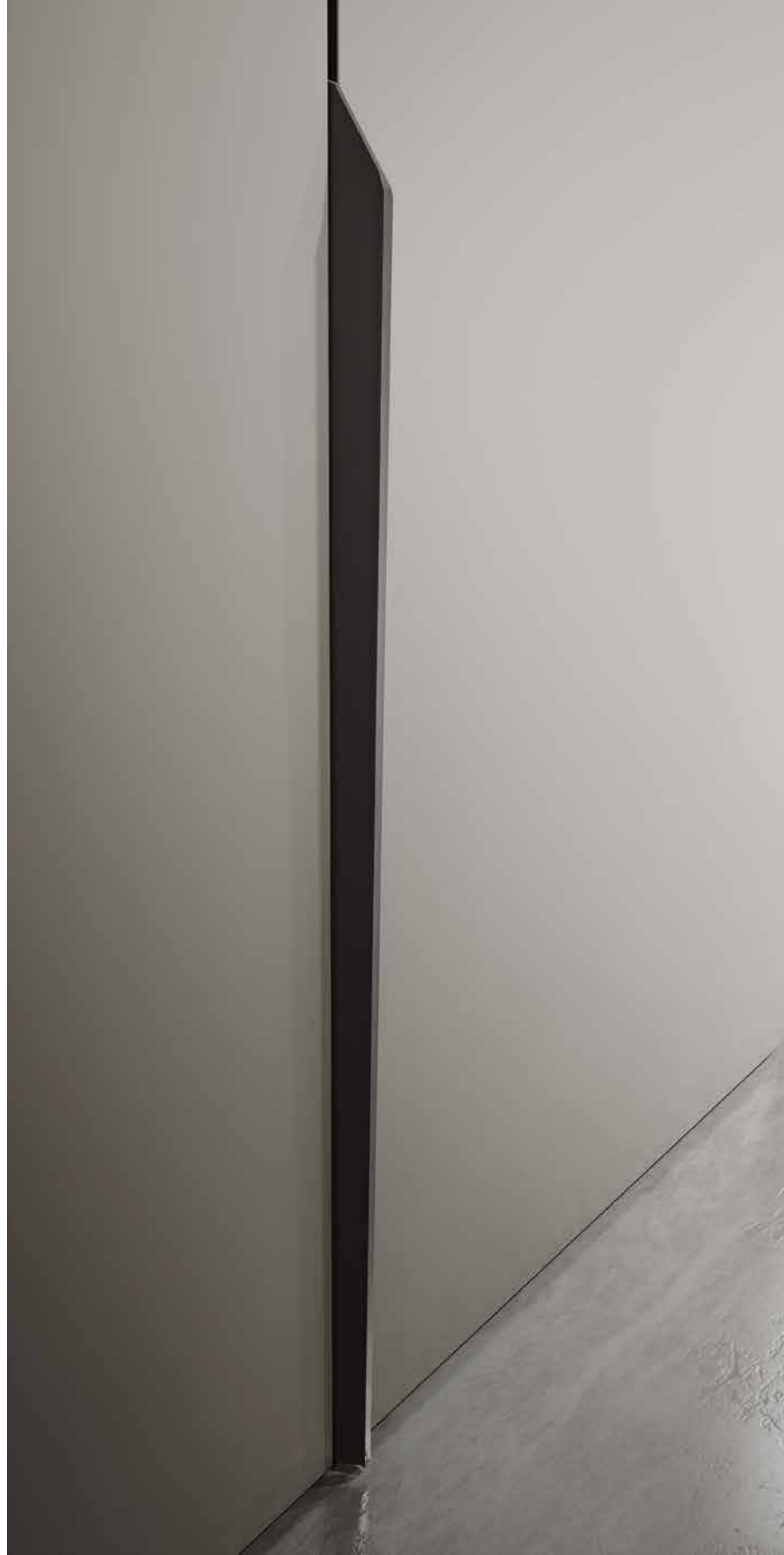

Corner wardrobe with built-in desk.

Armario rinconero con escritorio integrado.

Armoire d'angle avec bureau intégré.

Eckschrank integrierter Schreibtischplatte.

Угловой шкаф с встроенным письменным столом.





-
- Simple battente /swinging** L495,4 P62,4 H255,1
 Laccato opaco Arena, Maniglia 3D Moka shine /
 Matt Arena lacquer, 3D Moka Shine handle
- Simple scorrevole /sliding** L341,8 P67 H255,1
 Laccato opaco Arena, Maniglia 3D Moka shine /
 Matt Arena lacquer, 3D Moka Shine handle
- Viky sedia /chair** L59 P52 H76,5
-



**Simple/
Due tipologie,
una personalità.**

Two models,
one personality.

Dos tipos, una
personalidad.

Deux typologies, une
personnalité.

Die zwei Seiten einer
Persönlichkeit.

Два варианта, один
характер.



Simple battente /swinging L568 P62,4 H255,1

Fashion wood Rovere Terra, Maniglia C16 Moka shine /
Fashion Wood Terra oak, C16 Moka Shine handle

Simple scorrevole /sliding L341,8 P67 H255,1

Laccato opaco Sabbia, Maniglia C16 Moka shine /
Matt Sabbia lacquer, C16 Moka Shine handle





**Split/
Ambiente
giorno con
guardaroba
e zona TV**





Living space with wardrobe
and entertainment area

Ambiente de día con ropero
y zona TV

Espace jour avec garde-
robe et zone TV

Wohnbereich mit
Garderobe und TV-Zone

Гостиная с шкафом-купе и
ТВ-зоной



-
- Split battente /swinging** L454,9 P62,4 H255,1
 Fashion wood Rovere Carbone, Profilo Moka Shine /
 Fashion Wood Carbone oak, Moka Shine handle profile
- Split scorrevole /sliding** L454,9 P67 H255,1
 Laccato opaco Platino /
 Matt Platino lacquer
- Denny pouf /footstool** Ø55/85 H42/37
- Life tavolino /occasional table** L55 P45 H42

**Strip/
Un dialogo
di forme,
colori e
superfici**



A dialogue between
different shapes, colours
and surfaces

Un diálogo de formas,
colores y superficies

Un dialogue de formes,
coloris et surfaces

Formen, Farben und
Oberflächen in einem
spannenden Dialog

Диалог форм, цветов и
поверхностей



-
- Strip battente /swinging** L454,9 P62,4 H255,1
Laccato opaco Tortora, Rovere laccato opaco Tortora /
Matt Tortora lacquer, matt Tortora lacquered oak
- Strip scorrevole /sliding** L442,2 P67 H255,1
Laccato opaco Pacifico /
Matt Pacifico lacquer
- Denny pouf /footstool** Ø55/85/130 H42/32/37
- Wok tavolino /occasional table** Ø27,5 H50





Frame p. 88



Frame p. 78



Frame p. 82



Frame p. 66



Frame p. 74



Quadra p. 92



Vision p. 62



Rubic p. 114



Frame p. 90



Simple p. 106



Quadra p. 97



Quadra p. 100



Vision p. 70

SCORREVOLI

Sliding

Vision
Frame
Quadra
Simple
Rubic

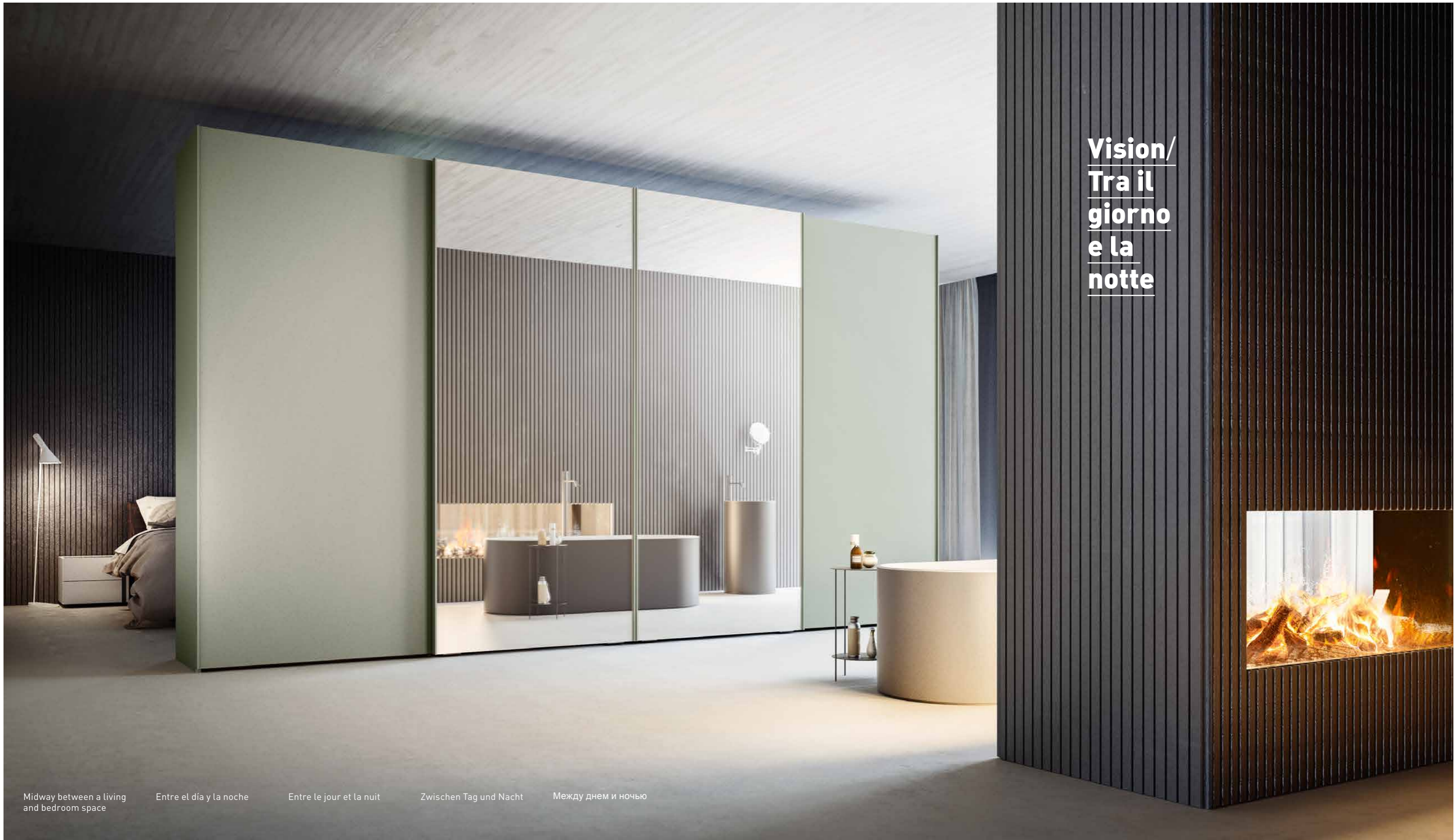

Vision/
Tra il
giorno
e la
notte

Midway between a living
and bedroom space

Entre el día y la noche

Entre le jour et la nuit

Zwischen Tag und Nacht

Между днем и ночью



Vision scorrevole /sliding L454,9 P67 H255,1 **ASOLO**_first floor

Specchio, Laccato opaco Tè verde, Profilo Laccato opaco Tè verde /
Mirror, matt Tè Verde lacquer, matt Tè Verde lacquered profile

Tuft tavolino /occasional table Ø40,3 H46,3

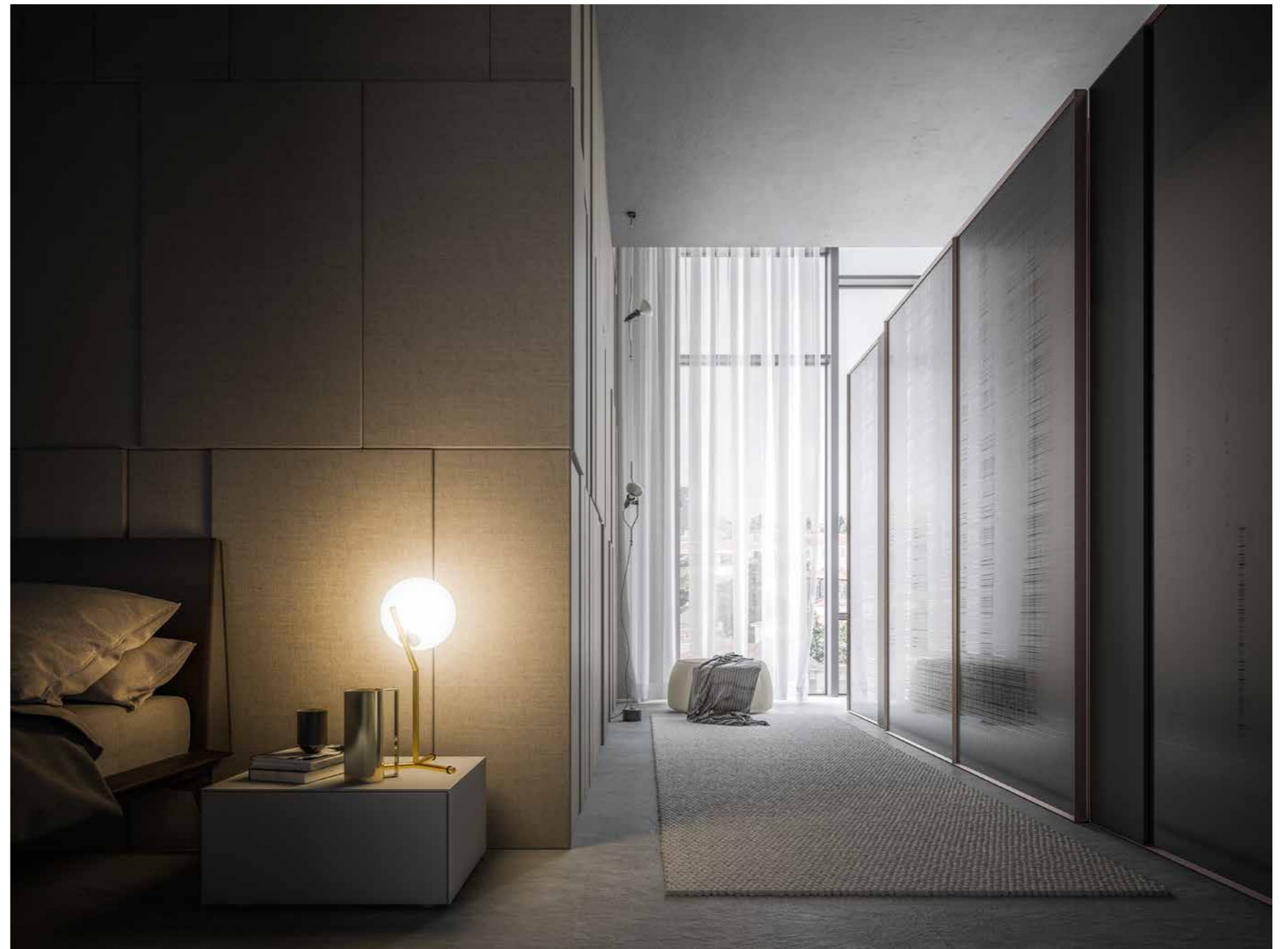

.....
Frame scorrevole /sliding **L393,3 P69 H255,1**

Vetro serigrafato Grigio lino, Laccato Modica opaco, Profilo Moka shine /
 Grigio Lino silk-screened glass, matt Modica lacquer, Moka Shine profile

**Frame/
Piani
e finiture
sovrapposte**



Overlapping surfaces and finishes

Superficies y acabados superpuestos

Plans et finitions superposées

Ein Spiel mit Ebenen und Flächen

Игра поверхностей и отделки

**Vision/
Risolve
qualsiasi
spazio**



Define any space

Una solución para cualquier espacio

Une solution à tout espace

Eine Lösung für jeden Raum

Для любого пространства



Full-length handle. Tirador de altura completa. Poignée sur toute la hauteur. Ein durchgehender Griff. Ручка по всей высоте.



Vision/ Maniglia a tutta altezza

Vision scorrevole /sliding	L341,8 P67 H255,1
<small>Vetro lucido Modica, Profilo Moka shine / Glossy Modica glass, Moka Shine profile</small>	
Allen letto /bed	L186 P215 H129
Hobby comodino /night stand	L41,7 P44 H42
Hobby comò /dresser	L134,2 P52,7 H75,4

**Frame/
Piani
e finiture
sovrapposte**

Overlapping surfaces and
finishes

Superficies y acabados
superpuestos

Plans et finitions
superposées

Ein Spiel mit Ebenen und
Flächen

Игра поверхностей и
отделки



.....
Frame scorrevole /sliding L341,8 P69 H255,1

Vetro acidato Platino, Fashion wood Rovere Fossile, profilo Moka shine /
 Platino etched glass, Fashion Wood Fossile oak, Moka Shine profile

Xilo letto /bed L174,5 P216 H95,2

Timeless comodino /night stand L60 P45 H43,7



**Frame/
Una
cornice
estetica e
funzionale**

A functional aesthetic
frame

Un marco estético y
funcional

Un cadre esthétique et
fonctionnel

Ein ästhetischer und
funktionaler Rahmen

Эстетичная и
функциональная рамка



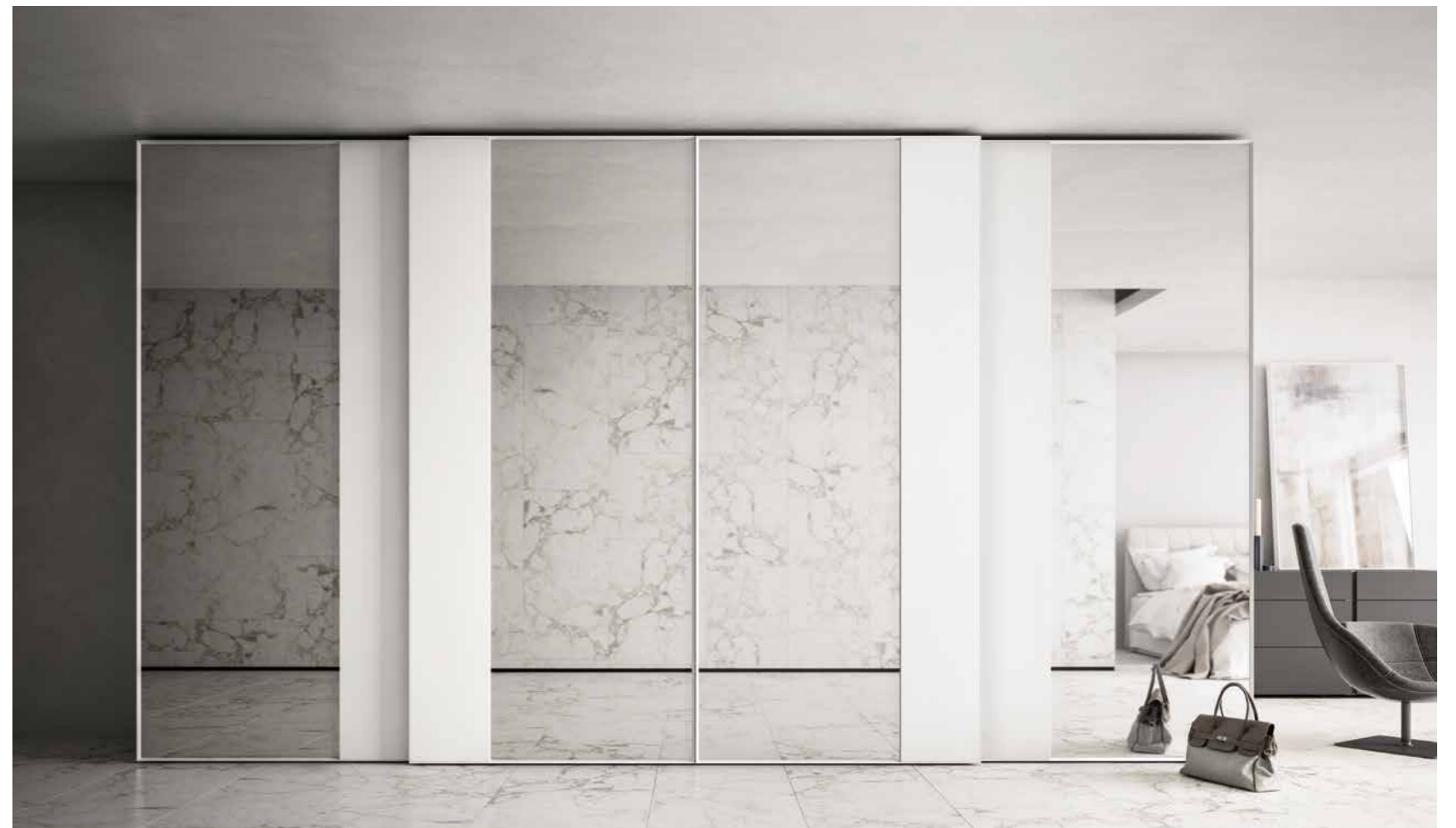

.....
Frame scorrevole /sliding L454,9 P69 H255,1

Specchio Grigio, Laccato opaco Calce, Profilo laccato opaco Calce /
 Grigio mirror, matt Calce lacquer, matt Calce lacquered profile

Da-do system comò /dresser L133 P53 H74,4

**Frame/
Suddividere
e organizzare
la casa**





Divide and organise your home

Dividir y organizar el hogar

Diviser et organiser la maison

Einteilung und Organisation für Ihr Zuhause

Подразделить и организовать дом

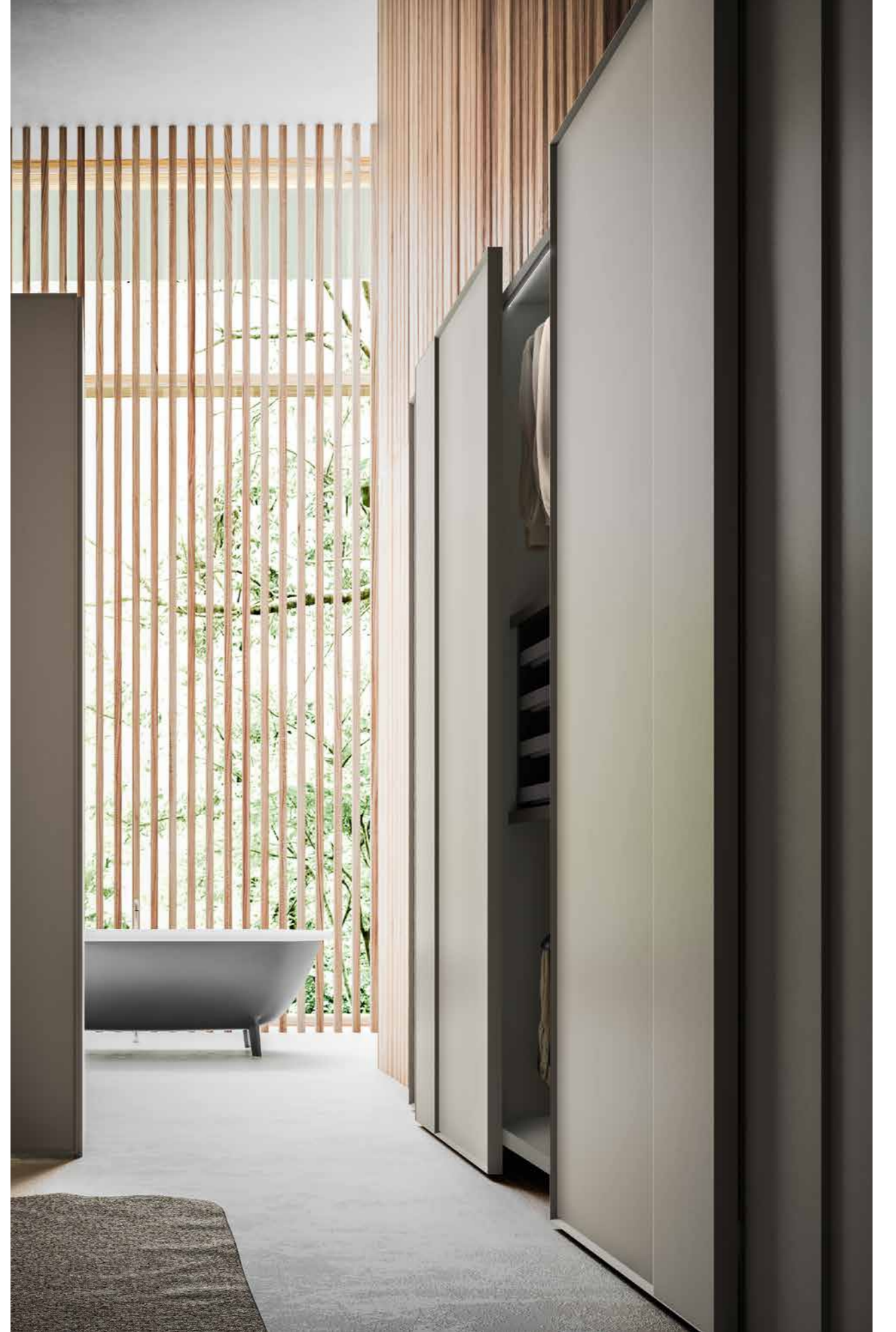



.....
Frame scorrevole/sliding	L454,9 P69 H255,1
Laccato opaco Platino / Matt Platino lacquer	
California letto/bed	L177 P230 H75
Fil moduli a sx /tsf units	L120 P48 H35,6
Fil moduli a dx /rsf units	L135 P48 H57,6
.....



Frame scorrevole /sliding L 341,8 P 69 H 255,1
 Vetro serigrafato Sari, Laccato opaco Platino, Profilo opaco Laccato Platino
 Sari silk-screened glass, matt Platino lacquer, matt Platino lacquered profile
Olivia poltroncina /armchair L 106 P 93 H 89
Tuft tavolini /occasional tables Ø 40,3 H 46,3
 Ø 60,3 H 36,8



Frame scorrevole /sliding L341,8 P69 H255,1

Vetro serigrafato Asà, Laccato opaco Platino, Profilo Laccato opaco Platino /
Asà silk-screened glass, matt Platino lacquer, matt Platino lacquered profile

Morrison letto /bed L197 P229 H92



**Quadra/
Riflessi
di luce e
venature
naturali**



Light reflections and
natural grain

Reflejos de luz y vetas
naturales

Reflets de lumière et
veinures naturelles

Lichtreflexe und natürliche
Maserungen

Отражение света и
натуральная текстура

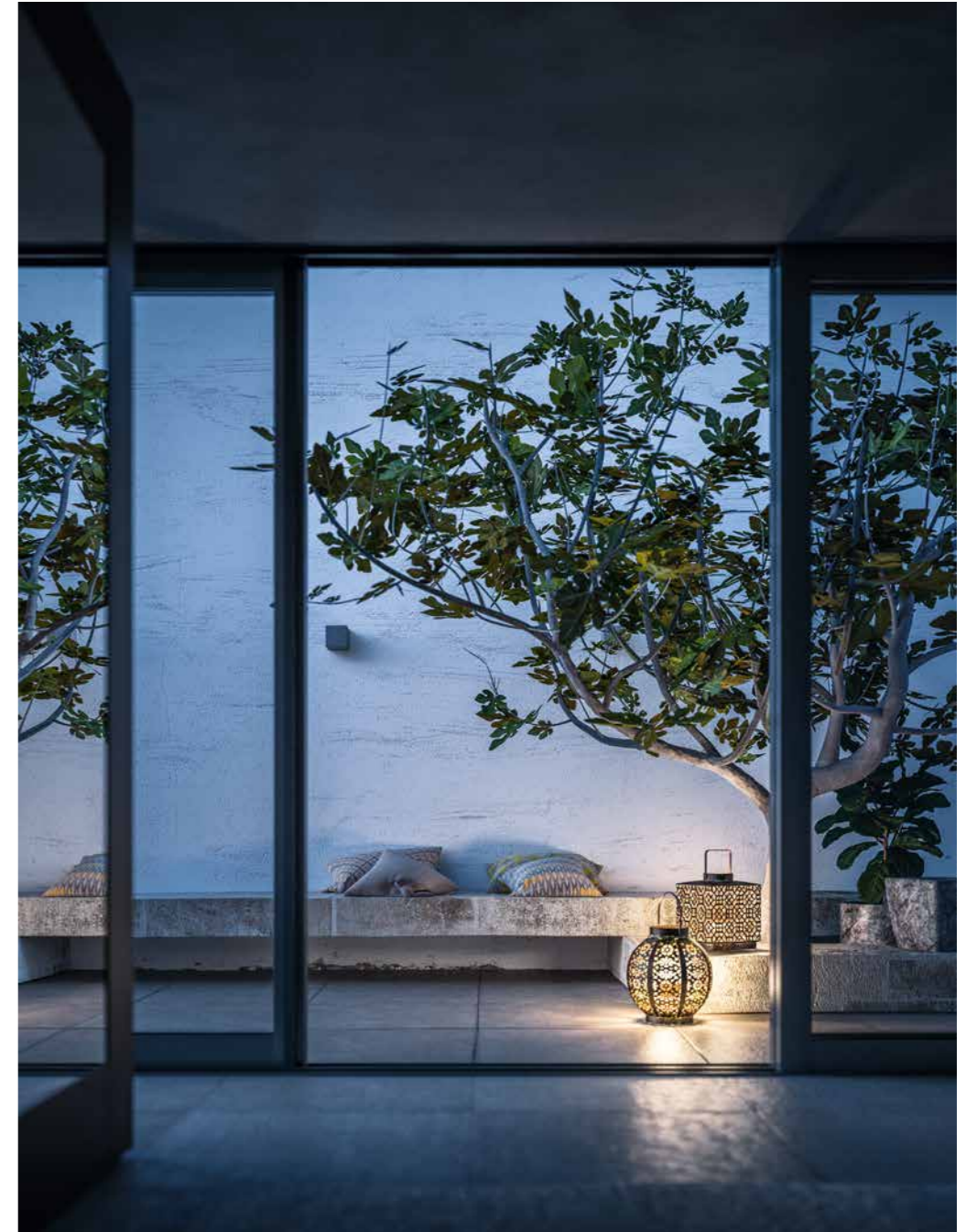

Quadra scorrevole /sliding L341,8 P67 H255,1
 Specchio Grigio, Fashion wood Rovere Carbone /
 Grigio mirror, Fashion Wood Carbone oak
Morrison letto /bed L197 P229 H92

**Quadra/
La valenza
architettonica
dell'armadio**

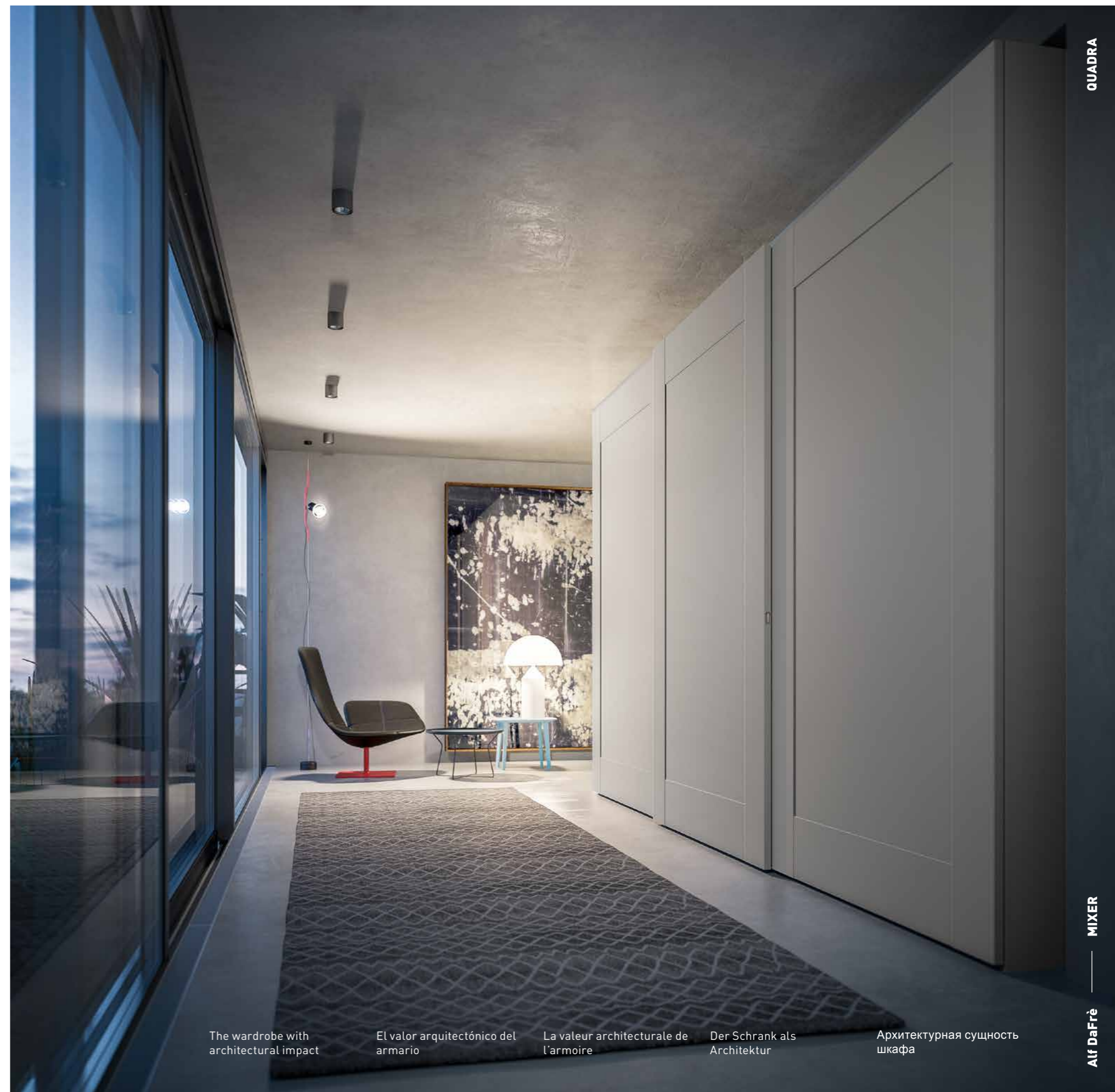

The wardrobe with
architectural impact

El valor arquitectónico del
armario

La valeur architecturale de
l'armoire

Der Schrank als
Architektur

Архитектурная сущность
шкафа



Quadra scorrevole /sliding L442,2 P67 H255,1

Laccato opaco Platino, Maniglia Inner /
Matt Platino lacquer, Inner handle

Tuft tavolino /occasional table Ø60,3 H36,8

Life tavolino /occasional table L55 P45 H42



**Quadra/
Materiali
e dettagli
artigianali**



Artisan materials and
details

Materiales y detalles
artesanales

Matériaux et détails
artisans

Handwerklich
verarbeitetes Material mit
besonderen Details

Материалы и детали
мастерской обработки

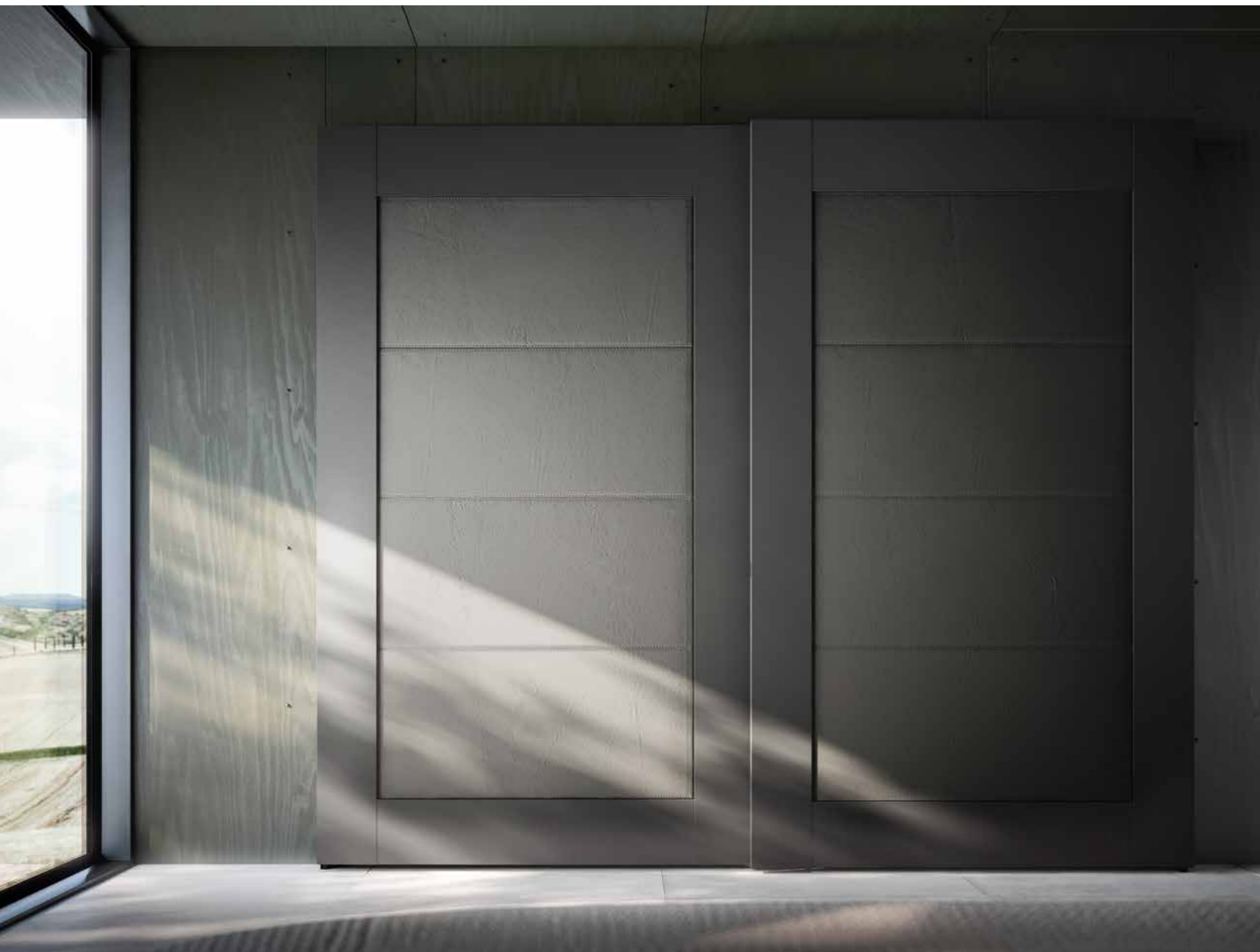

.....
Quadra scorrevole /sliding **L295,6 P67 H255,1**

Laccato opaco Modica, Pelle Lord 9190 /
 Matt Modica lacquer, Lord 9190 leather

Da-do system comodino /night stand **L90 P53 H37,1**

Wok box tavolino /occasional table **Ø35 H43**





A solution devised to combine a desk and a wardrobe, even in confined spaces.

Una solución estudiada para combinar el escritorio con el armario, incluso en poco espacio.

Une solution conçue pour associer bureau et armoire, même dans un espace réduit.

Eine perfekte Lösung, um Schreibtisch und Schrank auch auf engem Raum zu kombinieren.

Решение, разработанное для сочетания письменного стола и шкафа, даже в небольшом пространстве.



**Simple/
Accessori
intelligenti
per una vita
elegante**



Intelligent accessories
for an elegant lifestyle

Accesorios inteligentes
para una vida elegante

Accessoires intelligents
pour une vie élégante

Intelligente Accessoires
für mehr Eleganz

Искусные принадлежности
для элегантного стиля
жизни



Simple scorrevole /sliding L341,8 P67 H255,1

Laccato opaco Juta, Maniglia Nex, Laccato opaco Juta /
Matt Juta lacquer, Nex handle, matt Juta lacquer

Morrison letto /bed L197 P229 H92

Da-do system comodino /night stand L90 P45 H37,1

Denny pouf /footstool Ø55/85 H42/37

Tuft tavolino /occasional table Ø40,3/60,3 H46,3/36,8



**Rubic/
Un gioco
di piani
e volumi**

An exploration of shapes
and surfaces

Un juego de superficies y
volúmenes

Un jeu de plans et de
volumes

Flächen und Volumen in
Interaktion

Игра поверхностей и
объемов

Rubic scorrevole/sliding L341,8 P69 H255,1

Vetro lucido Calce, Profilo Laccato opaco Calce /
Glossy Calce glass, matt Calce lacquer profile



**Rubic/
Legno e
superfici
laccate
creano
particolari
geometrie**

Wood and lacquered surfaces create interesting shapes

Madera y superficies lacadas que crean formas especiales

Le bois et les surfaces laquées créent des géométries particulières

Holz und lackierte Oberflächen schaffen ein außergewöhnliches Muster

Дерево и крашенные поверхности в создании характерных форм



Rubic scorrevole /sliding L295,6 P138 (69x2) H255,1

Laccato opaco Fango, Fashion wood Rovere Carbone, Profilo Moka shine /
Matt Fango lacquer, Fashion Wood Carbone oak, Moka Shine profile

Mixer isola cassetti esterna /external drawers island L384,6 (192,3x2) P100 H77,9

Eukalipto Cenere / Eukalipto Cenere







Glide p. 124

COMPLANARI

Coplanar

Glide



GLIDE/
Complanarità
ed essenzialità
pura



.....
Glide complanare /coplanar **L341,8 P62,3 H255,1**
Laccato opaco Platino / Matt Platino lacquer



Coplanar and utterly sleek

Coplanaridad y esencia pura

Coplanarité et essentiel pur

Die reine Schlichtheit der Geometrie

Компланарность и настоящая сущность

TIPOLOGIE ANTE	
Door type	p. 130
MANIGLIE	
Handles	p. 140
TIPOLOGIE DI APERTURA	
Types of opening	p. 142
STRUTTURA ARMADIO	
Wardrobe structure	p. 143
MODULARITÀ	
Modular units	p. 144
ORGANIZZAZIONE DEGLI INTERNI	
Organising the inside	p. 148
FINITURE INTERNE	
Internal finishes	p. 150
ESEMPI DI ABBINAMENTO TRA SCOCCA, SCHIENA E ATTREZZATURE INTERNE	
Examples of combinations of bodies, back panels and internal fittings	p. 152
DETTAGLI	
Details	p. 154
ILLUMINAZIONE	
Lighting	p. 155
TIPOLOGIE RIPIANI, COPERCHI, CASSETTI E VASSOI	
Types of shelves, cover tops, drawers and trays	p. 158
FINITURE CASSETTI E VASSOI	
Drawer and tray finishes	p. 162
ACCESSORI PER CASSETTI E VASSOI	
Accessories for drawers and trays	p. 164
PROPOSTE ACCESSORI PER CASSETTI E VASSOI	
Examples of accessories for drawers and trays	p. 165
ELEMENTI SOSPESI E SOLUZIONI PORTASCARPE	
Floating units and shoe rack solutions	p. 166
RASTER	
Cubby-hole units	p. 167
APPENDERIA	
Hanging rails	p. 168
SPECCHI INTERNI	
Internal mirrors	p. 170
ISOLA CASSETTI ESTERNA	
External drawer-unit island	p. 171
MODULI	
Units	p. 172
VETRI SERIGRAFATI	
Silk-screen printed glass	p. 177

Ante battenti / scorrevoli

/Swinging/sliding doors
/Puertas batientes / correderas
/Portes battantes / coulissantes
/Drehtüren / Schiebetüren
/Распашные / раздвижные створки

Display

Apertura battente / Swinging opening

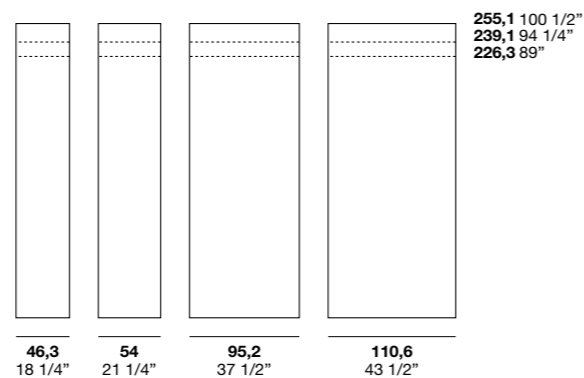

Finiture frontale / Front finishes:

Specchio / Mirror
Specchio Grigio / Grigio Mirror
Vetro Trasparente Grigio / Grigio transparent glass

Finiture telaio, maniglia integrata / Frame and built-in handle finishes:

Verniciato Moka shine / Painted Moka Shine

Display

Apertura scorrevole / Sliding opening

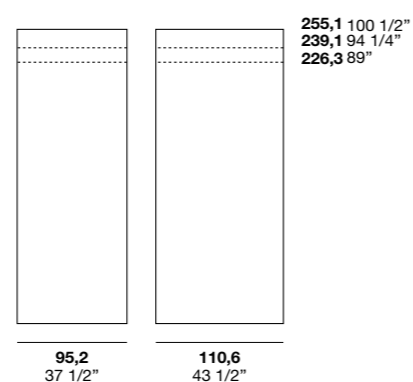

Finiture frontale / Front finishes:

Specchio / Mirror
Specchio Grigio / Grigio mirror
Vetro Trasparente Grigio / Grigio transparent glass

Finiture telaio, maniglia integrata / Frame and built-in handle finishes:

Verniciato Moka shine / Painted Moka Shine

Rain

Apertura battente / Swinging opening

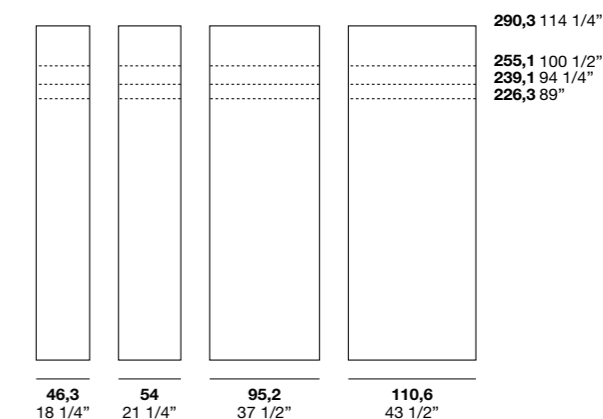

Finiture frontale / Front finishes:

Fashion Wood / Fashion Wood
Roveri Laccati Opachi / Matt lacquered oak
Laccati Opachi Base (Bianco, Tortora) / Basic matt lacquer (Bianco, Tortora)
Laccati Opachi / Matt lacquer

Maniglie disponibili / Handles available

Pomolo
Pomolo Pelle
Nex
C16
T16
Elios
3D
G11

Rain

Apertura scorrevole / Sliding opening

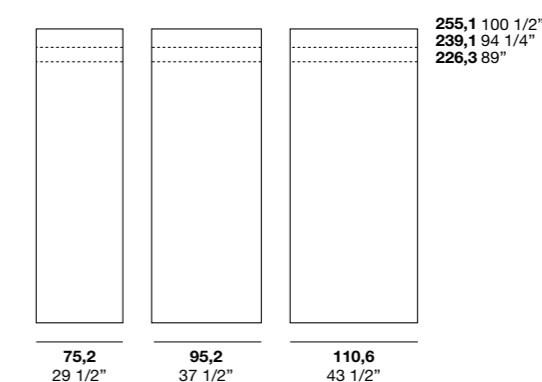

Finiture frontale / Front finishes:

Fashion Wood / Fashion Wood
Roveri Laccati Opachi / Matt lacquered oak
Laccati Opachi Base (Bianco, Tortora) / Basic matt lacquer (Bianco, Tortora)
Laccati Opachi / Matt lacquer

Maniglie disponibili / Handles available

Inner
Nex
C16
T16
3D
G11

Ante battenti / scorrevoli

/Swinging/sliding doors
/Puertas batientes / correderas
/Portes battantes / coulissantes
/Drehtüren / Schiebetüren
/Распашные / раздвижные створки

Simple

Apertura battente / Swinging opening

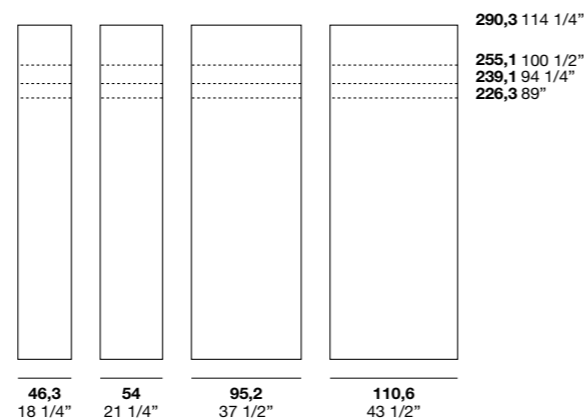

Finiture frontale / Front finishes:

Fashion Wood / Fashion Wood
Roveri Laccati Opachi / Matt lacquered oak
Laccati Opachi Base (Bianco, Tortora) / Basic matt lacquer (Bianco, Tortora)
Laccati Opachi / Matt lacquer
Laccati Lucidi / High-gloss lacquer

Maniglie disponibili / Handles available

Pomolo
Pomolo Pelle
Nex
C16
T16
Elios
3D
G11

Simple

Apertura scorrevole / Sliding opening

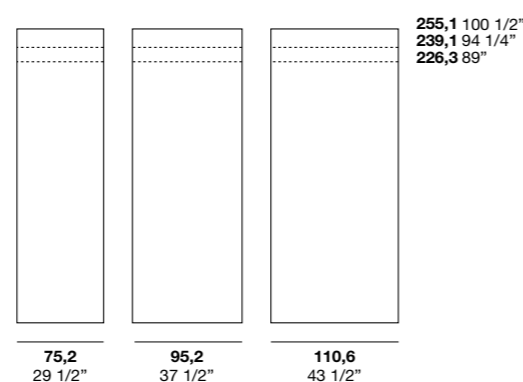
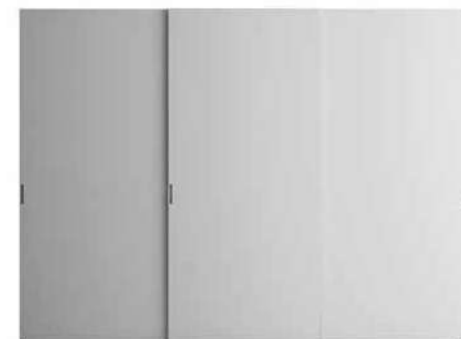

Finiture frontale / Front finishes:

Fashion Wood / Fashion Wood
Roveri Laccati Opachi / Matt lacquered oak
Laccati Opachi Base (Bianco, Tortora) / Basic matt lacquer (Bianco, Tortora)
Laccati Opachi / Matt lacquer
Laccati Lucidi / High-gloss lacquer

Maniglie disponibili / Handles available

Inner
Nex
C16
T16
3D
G11

Split

Apertura battente / Swinging opening

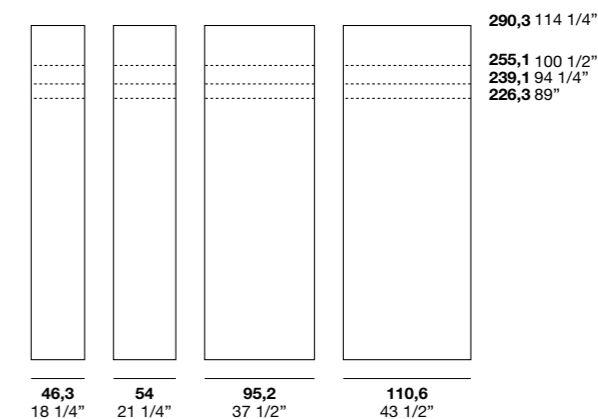

Finiture frontale / Front finishes:

Fashion Wood / Fashion Wood
Roveri Laccati Opachi / Matt lacquered oak
Laccati Opachi Base (Bianco, Tortora) / Basic matt lacquer (Bianco, Tortora)
Laccati Opachi / Matt lacquer
Laccati Lucidi / High-gloss lacquer

Finiture maniglia integrata / Integrated handle finishes

Verniciato Moka shine / Painted Moka Shine
Laccati Opachi / Matt lacquer

Split

Apertura scorrevole / Sliding opening

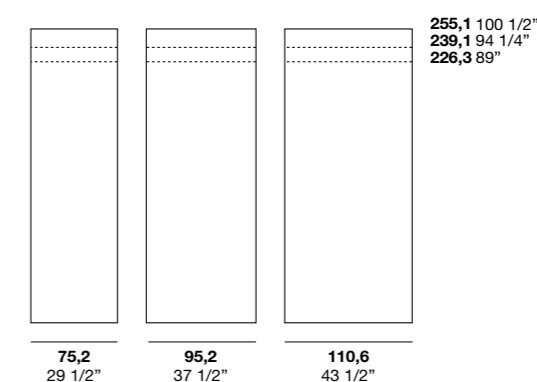

Finiture frontale / Front finishes:

Fashion Wood / Fashion Wood
Roveri Laccati Opachi / Matt lacquered oak
Laccati Opachi Base (Bianco, Tortora) / Basic matt lacquer (Bianco, Tortora)
Laccati Opachi / Matt lacquer
Laccati Lucidi / High-gloss lacquer

Finiture maniglia integrata / Integrated handle finishes

Verniciato Moka shine / Painted Moka Shine
Laccati Opachi / Matt lacquer

* L'anta esterna ha sempre due maniglie integrate /L'anta esterna ha sempre due maniglie integrate / the external door always has 2 integrated handles

Ante battenti / scorrevoli

/Swinging/sliding doors
/Puertas batientes / correderas
/Portes battantes / coulissantes
/Drehtüren / Schiebetüren
/Распашные / раздвижные створки

Strip

Apertura battente / Swinging opening

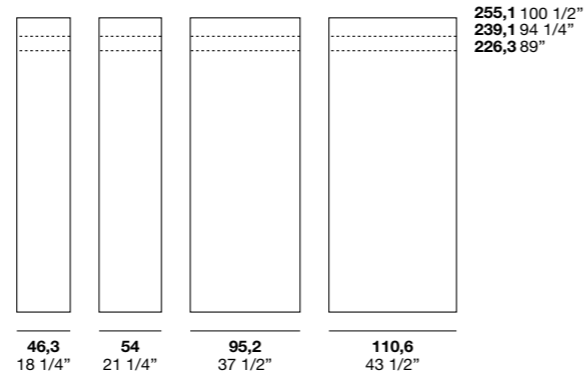

Finiture pannello / Panel finishes:

Fashion Wood / Fashion Wood
Roveri Laccati Opachi / Matt lacquered oak
Laccati Opachi Base (Bianco, Tortora) / Basic matt lacquer (Bianco, Tortora)
Laccati Opachi / Matt lacquer

Finiture fascia maniglia / Handle strip finishes

Roveri Laccati Opachi / Matt lacquered oak
Laccati Opachi Base (Bianco, Tortora) / Basic matt lacquer (Bianco, Tortora)
Laccati Opachi / Matt lacquer
Laccati Lucidi / High-gloss lacquer

Strip

Apertura scorrevole / Sliding opening

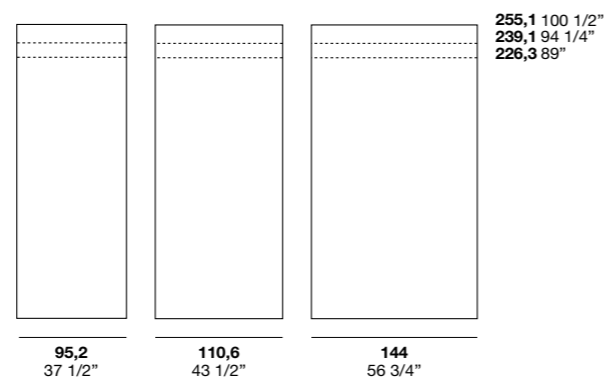

Finiture pannello / Panel finishes:

Fashion Wood / Fashion Wood
Roveri Laccati Opachi / Matt lacquered oak
Laccati Opachi Base (Bianco, Tortora) / Basic matt lacquer (Bianco, Tortora)
Laccati Opachi / Matt lacquer

Finiture fascia maniglia / Handle strip finishes

Roveri Laccati Opachi / Matt lacquered oak
Laccati Opachi Base (Bianco, Tortora) / Basic matt lacquer (Bianco, Tortora)
Laccati Opachi / Matt lacquer
Laccati Lucidi / High-gloss lacquer

Ante scorrevoli

/Sliding doors
/Puertas correderas
/Portes coulissantes
/Schiebetüren
/Раздвижные створки

Vision

Apertura scorrevole / Sliding opening

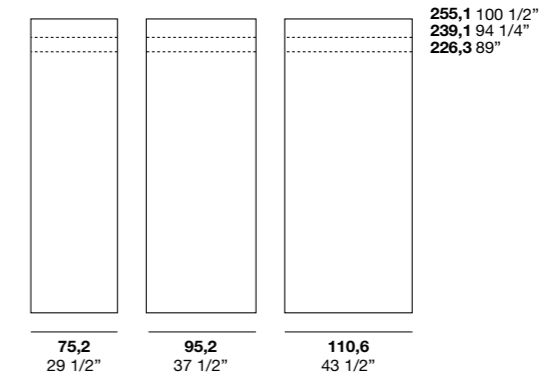
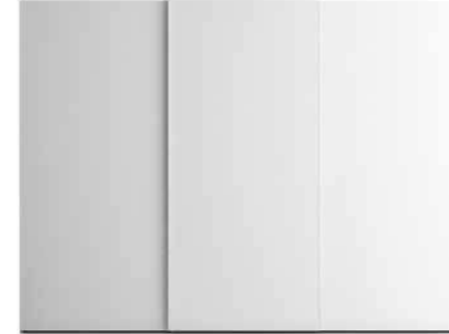

Finiture frontale / Front finishes:

Fashion Wood / Fashion Wood
Roveri Laccati Opachi / Matt lacquered oak
Laccati Opachi Base (Bianco, Tortora) / Basic matt lacquer (Bianco, Tortora)
Laccati Opachi / Matt lacquer
Laccati Lucidi / High-gloss lacquer
Specchio / Mirror
Specchio Grigio / Grigio mirror
Vetri Lucidi / High-gloss glass
Vetri Acidati / Etched glass

Finiture profilo, maniglia integrata / Profile and built-in handle finishes

Verniciato Moka shine / Verniciato Moka shine
Laccati Opachi / Matt lacquer

Frame

Apertura scorrevole / Sliding opening

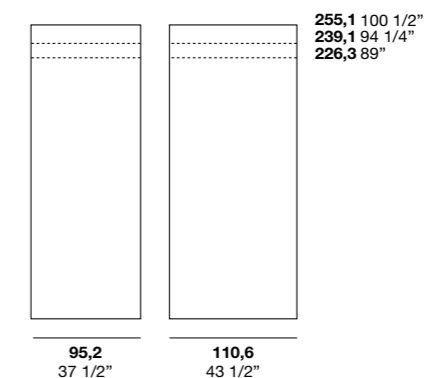

Finiture pannello / Panel finishes:

Fashion Wood / Fashion Wood
Roveri Laccati Opachi / Matt lacquered oak
Laccati Opachi Base (Bianco, Tortora) / Basic matt lacquer (Bianco, Tortora)
Laccati Opachi / Matt lacquer
Specchio / Mirror
Specchio Grigio / Grigio mirror
Vetri Lucidi / High-gloss glass
Vetri Acidati / Etched glass
Vetri serigrafati / Silk-screen printed glass

Finiture profilo, maniglia integrata / Profile and built-in handle finishes

Verniciato Moka shine / Painted Moka Shine
Laccati Opachi / Matt lacquer

Finiture fascia / Strip finishes

Fashion Wood / Fashion Wood
Roveri Laccati Opachi / Matt lacquered oak
Laccati Opachi Base (Bianco, Tortora) / Basic matt lacquer (Bianco, Tortora)
Laccati Opachi / Matt lacquer
Laccati Lucidi / High-gloss lacquer

Ante scorrevoli

/Sliding doors
/Puertas correderas
/Portes coulissantes
/Schiebetüren
/Раздвижные створки

Quadra

Apertura scorrevole / Sliding opening

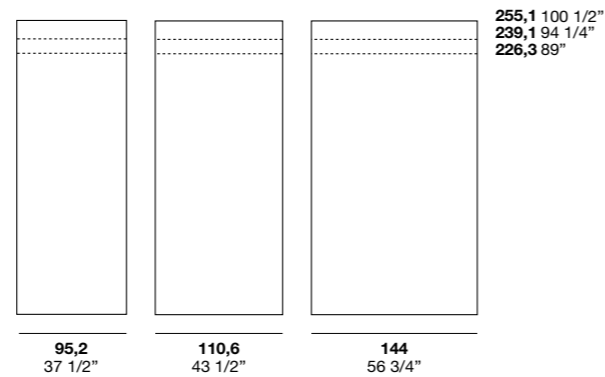
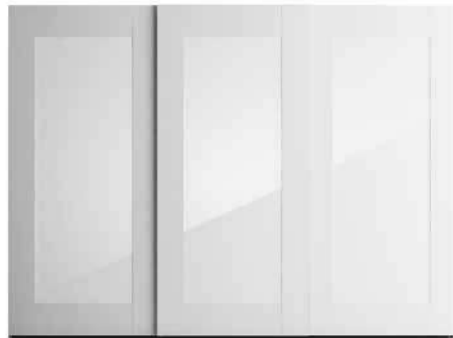

Finiture pannello / Panel finishes:

Fashion Wood / Fashion Wood
Roveri Laccati Opachi / Matt lacquered oak
Laccati Opachi Base (Bianco, Tortora)
/Basic matt lacquer (Bianco, Tortora)
Laccati Opachi /Laccati Opachi
High-gloss lacquer
Specchio / Mirror
Specchio Grigio / Grigio mirror
Vetri Lucidi / High-gloss glass
Vetri Acidati / Etched glass
Ecopelli - Pelli / Faux leather - Leather*

* Il pannello ha quattro cuciture / The panel has 4 seams

Finiture cornice / Frame finishes:

Fashion Wood / Fashion Wood
Roveri Laccati Opachi / Matt lacquered oak
Laccati Opachi Base (Bianco, Tortora)
/Basic matt lacquer (Bianco, Tortora)
Laccati Opachi /Laccati Opachi
High-gloss lacquer

Maniglia integrata / Built-in handle

Inner

Rubic

Apertura scorrevole / Sliding opening

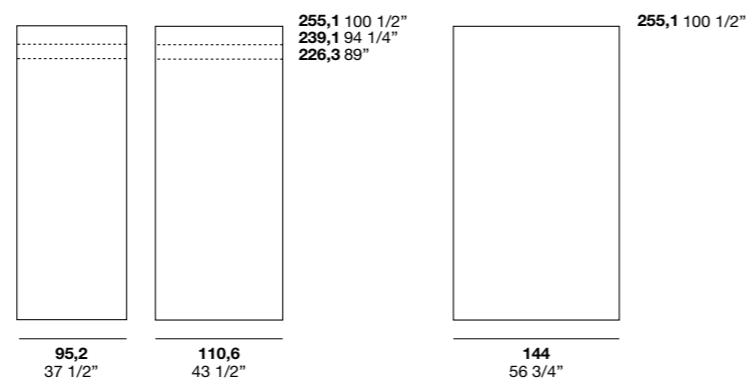
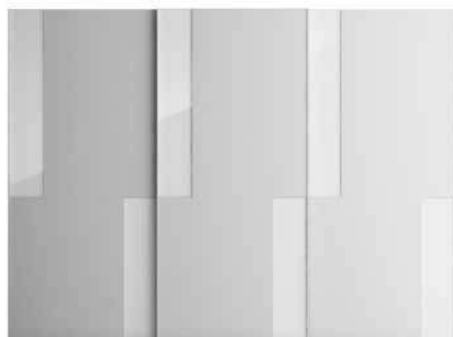

Finiture pannelli grandi / Large panel finishes

Fashion Wood / Fashion Wood
Roveri Laccati Opachi / Matt lacquered oak
Laccati Opachi Base (Bianco, Tortora)
/Basic matt lacquer (Bianco, Tortora)
Laccati Opachi / Matt lacquer
Laccati Lucidi / High-gloss lacquer
Vetri Lucidi / High-gloss glass*
Vetri Acidati / Etched glass*

Finiture pannelli piccoli / Small panel finishes

Fashion Wood / Fashion Wood
Roveri Laccati Opachi / Matt lacquered oak
Laccati Opachi Base (Bianco, Tortora)
/Basic matt lacquer (Bianco, Tortora)
Laccati Opachi / Matt lacquer
Laccati Lucidi / High-gloss lacquer
Vetri Lucidi / High-gloss glass*
Vetri Acidati / Etched glass*

Finiture profilo, maniglia integrata / Profile and built-in handle finishes

Verniciato Moka shine / Painted Moka Shine
Laccati Opachi / Matt lacquer

* Nel caso di ante completamente vetro i pannelli grandi non sporgono rispetto ai pannelli piccoli
/For full-glass doors, the large panels do not jut out with respect to the small panels

Ante scorrevoli e complanari

/Sliding and coplanar doors
/Puertas correderas y coplanares
/Portes coulissantes et coplanaires
/Schiebetüren und komplanare Türen
/Раздвижные и компланарные створки

Glide

Apertura scorrevole / Sliding opening

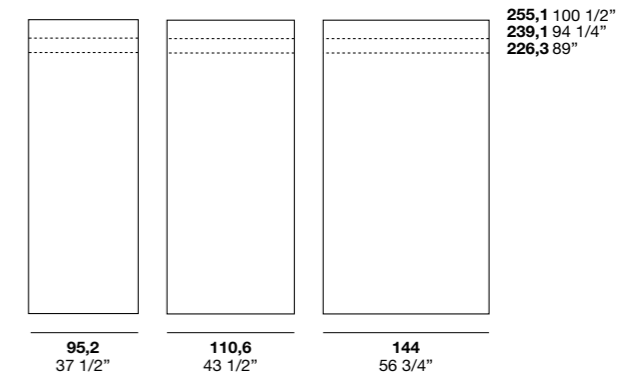
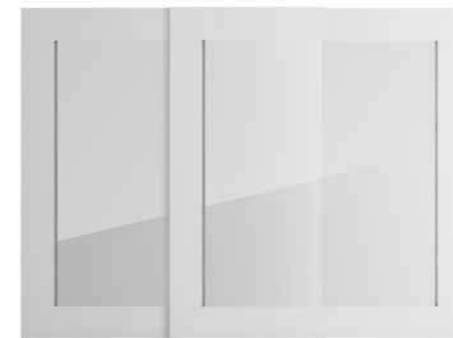

Finiture pannello / Panel finishes

Laccati Opachi Base (Bianco, Tortora)
/Basic matt lacquer (Bianco, Tortora)
Laccati Opachi / Matt lacquer
Laccati Lucidi / High-gloss lacquer

Sempre corredata di maniglia Inner / Inner handle always used

Finiture fascia / Finiture fascia

Laccati Opachi Base (Bianco, Tortora)
/Basic matt lacquer (Bianco, Tortora)
Laccati Opachi / Matt lacquer
Laccati Lucidi / High-gloss lacquer

Finiture maniglia integrata / Integrated handle finishes

Verniciato Moka shine / Painted Moka Shine
Laccati Opachi / Matt lacquer

Glide

Apertura complanare / Coplanar opening

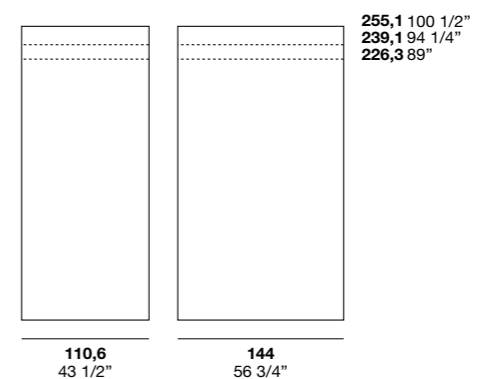
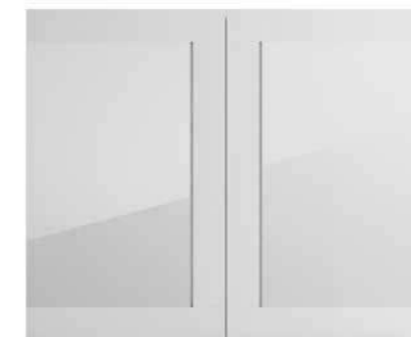

Finiture pannello / Panel finishes

Laccati Opachi Base (Bianco, Tortora)
/Basic matt lacquer (Bianco, Tortora)
Laccati Opachi / Matt lacquer
Laccati Lucidi / High-gloss lacquer

Finiture fascia / Strip finishes

Laccati Opachi Base (Bianco, Tortora)
/Basic matt lacquer (Bianco, Tortora)
Laccati Opachi / Matt lacquer
Laccati Lucidi / High-gloss lacquer

Finiture maniglia integrata / Integrated handle finishes

Verniciato Moka shine / Painted Moka Shine
Laccati Opachi / Matt lacquer

Maniglie

/Handles
/Tiradores
/Poignées
/Griffe
/Ручки



Pomolo
Maniglia per anta battente.
Finiture: Nichel satinato.
/Handle for swinging door.
Finishes: satin-finish nickel.



Pomolo pelle
Maniglia per anta battente.
Finiture: verniciato Moka shine e cuoio grigio.
/Handle for swinging door.
Finishes: painted Moka Shine and Grigio leather.



Nex
Maniglia per anta battente e scorrevole. Finiture:
laccati opachi, verniciato Moka shine.
/Handle for swinging and sliding door. Finishes:
matt lacquer, painted Moka Shine.



Inner
Maniglia per anta scorrevole.
Finiture: Nichel satinato.
/Handle for sliding door.
Finishes: satin-finish nickel.

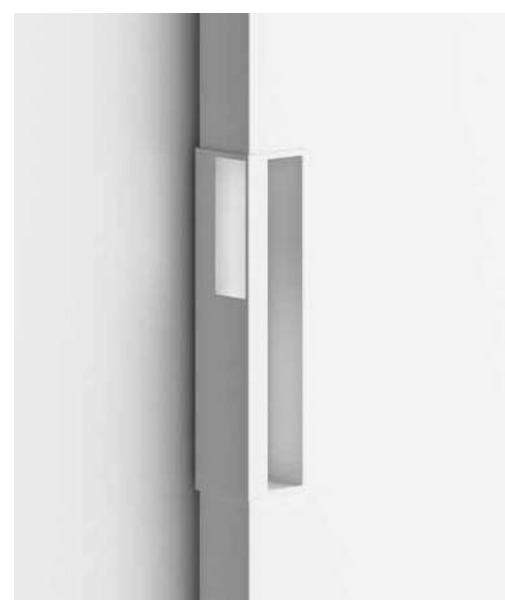

C16
Maniglia per anta battente e scorrevole. Finiture:
laccati opachi, verniciato Moka shine.
/Handle for swinging and sliding door. Finishes:
matt lacquer, painted Moka Shine.



T16
Maniglia per anta battente e scorrevole. Finiture:
laccati opachi, verniciato Moka shine.
/Handle for swinging and sliding door. Finishes:
matt lacquer, painted Moka Shine.



Elios
Maniglia per anta battente.
Finiture: laccati opachi, laccati lucidi, fashion
wood, roveri laccati opachi.
/Handle for swinging door.
Finishes: matt lacquer, high-gloss lacquer,
Fashion Wood, matt lacquered oak.



3D
Maniglia per anta battente e scorrevole. Finiture:
laccati opachi, verniciato Moka shine
/Handle for swinging and sliding door. Finishes:
matt lacquer, painted Moka Shine.



G11
Maniglia per anta battente e scorrevole. Finiture:
laccati opachi, verniciato Moka shine.
/Handle for swinging and sliding door. Finishes:
matt lacquer, painted Moka Shine.

Tipologie di apertura

/Types of opening
/Tipos de apertura
/Typologies d'ouverture
/Öffnungsarten
/Варианты открытия

Battente / Swinging

Le ante battenti sono dotate di cerniere con chiusura assistita*
/The swinging doors are equipped with assisted-closing hinges*

ante /doors

Display
Rain
Simple
Sliver
Split
Strip

* Tranne nei moduli spogliatoio, angolo, terminale
/Except for dressing closet, corner and end units

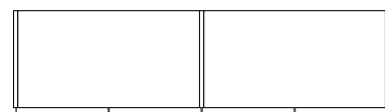
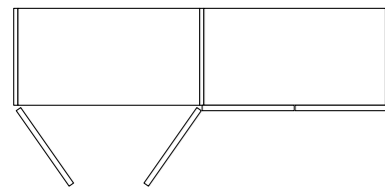
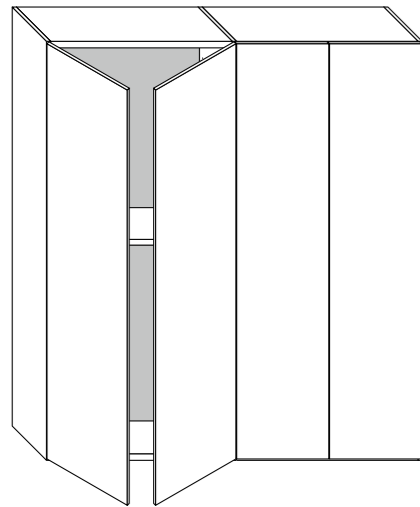

Scorrevole / Sliding

Le ante scorrevoli sono dotate di meccanismo per la chiusura assistita.
/The sliding doors are equipped with an assisted-closing mechanism.

ante /doors

Display
Vision
Frame
Quadra
Rain
Simple
Split
Strip
Rubic
Glide

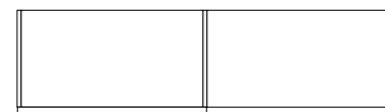
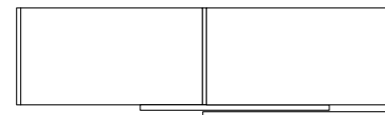
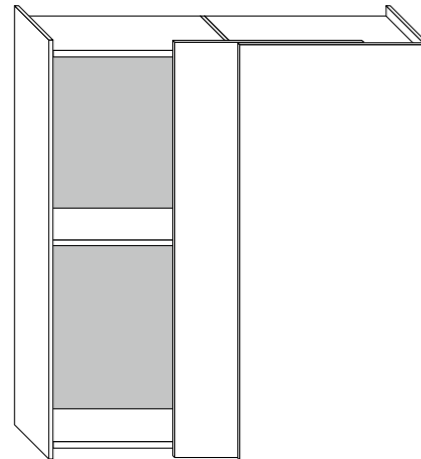

Complanare / Coplanar

Le ante complanari sono dotate di meccanismo per la chiusura assistita.
/The coplanar doors are equipped with an assisted-closing mechanism.

ante /doors

Glide

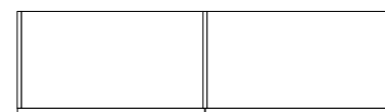
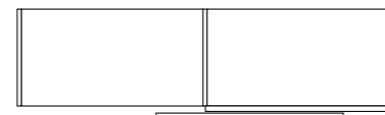
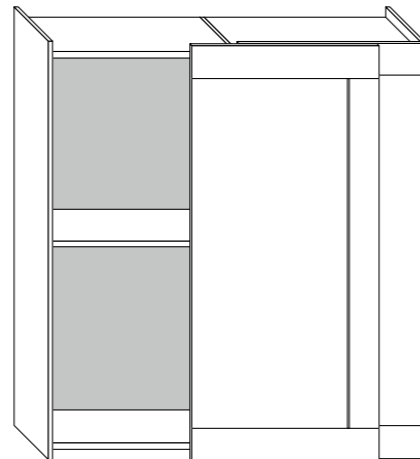

Plus ante scorrevoli e complanari / Plus sliding and coplanar doors

La progettazione dei nostri armadi con apertura scorrevole o complanare permette, in configurazione chiusa, la totale sovrapposizione delle ante ai fianchi.
/The design of our wardrobes with a sliding or coplanar opening means that the doors fully overlap with the side panels when closed.

Struttura armadio

/Wardrobe structure
/Estructura del armario
/Structure armoire
/Korpus Schrank
/Каркас шкафа

Struttura battente / Swinging structure

- 1 - Fianco /Side panel
- 2 - Divisione /Partition
- 3 - Coperchio /Top
- 4 - Schiena /Back panel
- 5 - Fondo /Bottom
- 6 - Ripiano /Shelf
- 7 - Tubo appendiabiti /Clothes rail

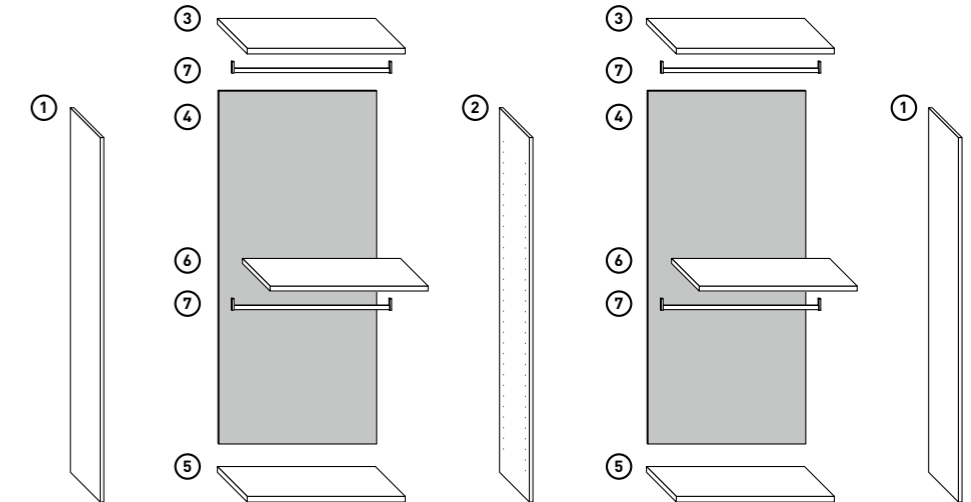

Struttura scorrevole, complanare / Sliding, coplanar structure

- 1 - Fianco /Side panel
- 2 - Divisione scorrevole /Sliding partition
- 3 - Divisione complanare /Coplanar partition
- 4 - Coperchio /Top
- 5 - Schiena /Schiena
- 6 - Fondo /Bottom
- 7 - Ripiano /Shelf
- 8 - Tubo appendiabiti /Clothes rail
- 10 - Binario superiore complanare /Upper coplanar track
- 11 - Binario inferiore scorrevole /Lower sliding track
- 12 - Binario inferiore complanare /Lower coplanar track
- 13 - Barra di rinforzo /Support bar

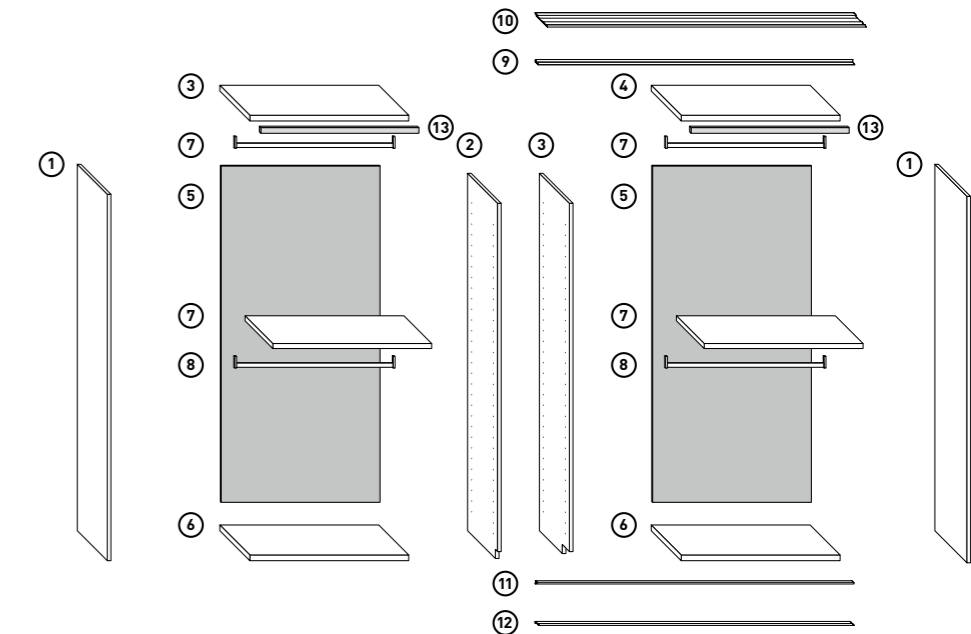

Tipologie ripiani / Types of shelving

- 1 - Ripiano /Shelf
- 2 - Ripiano in vetro trasparente grigio con telaio alluminio finitura grigio fumo /Grigio transparent glass shelf with aluminium frame, Grigio Fumo finish
- 3 - Ripiano in vetro trasparente grigio con telaio alluminio finitura grigio fumo e luce a led /Grigio transparent glass shelf with aluminium frame, Grigio Fumo finish and LED light

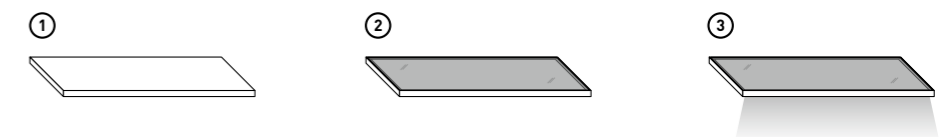

Modularità battente

/Swinging modular units
 /Modularidad puerta batiente
 /Modularité battante
 /Module Drehtür
 /Модульность распашных шкафов

Altezze / Heights

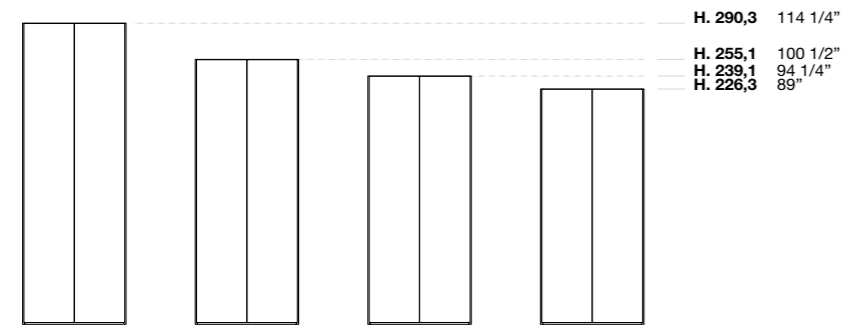

Moduli / Units

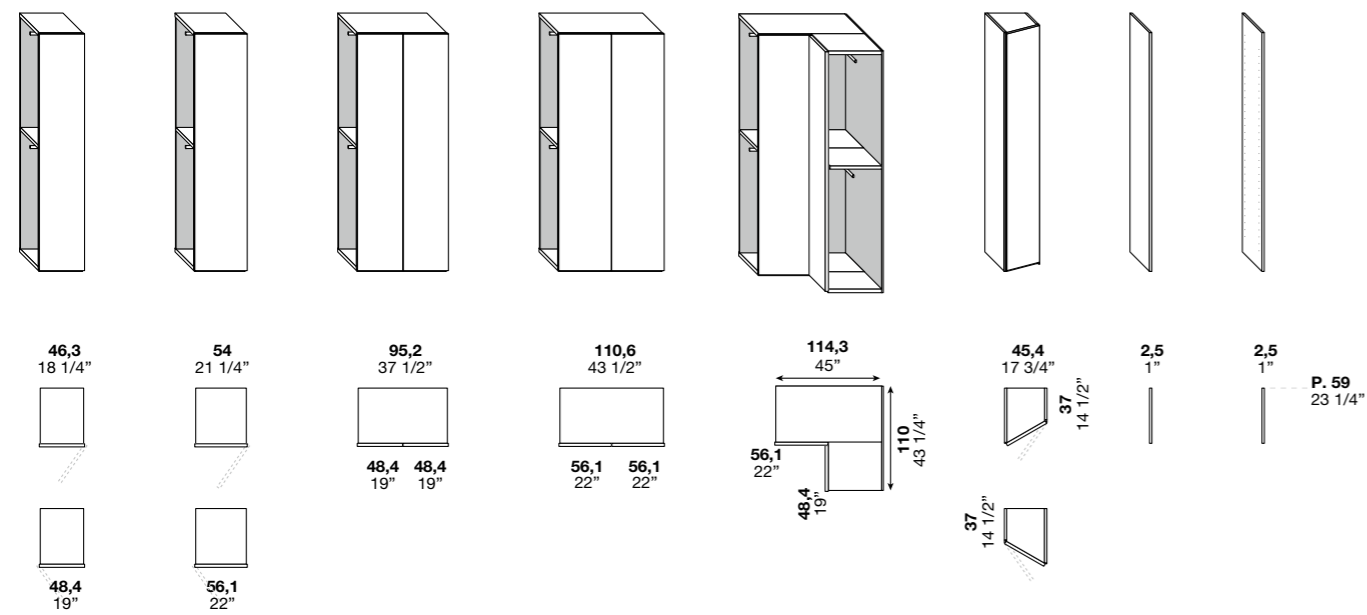

Vani a giorno / Open compartments

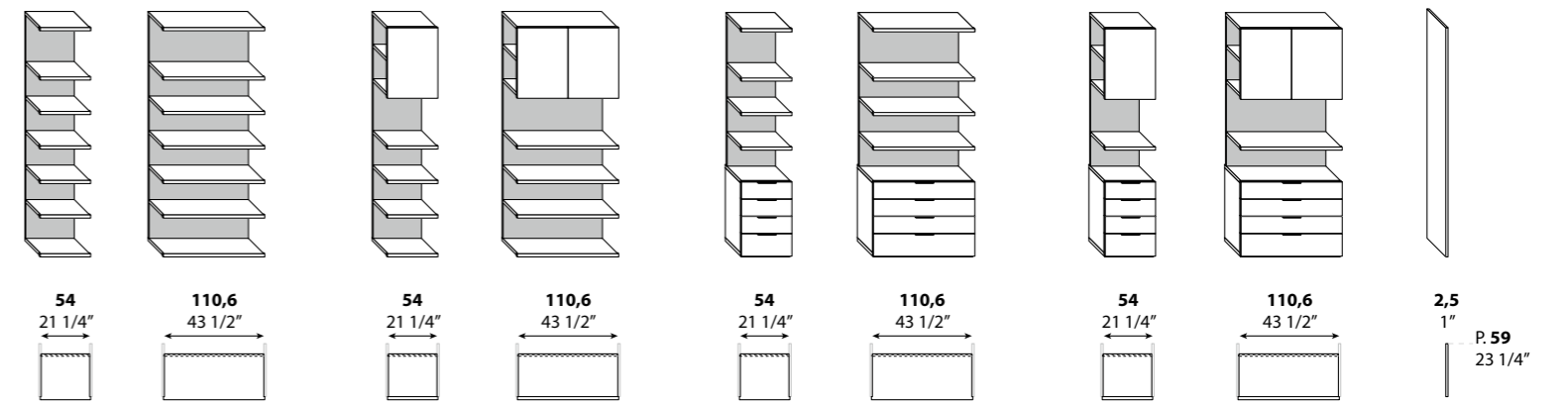

Ponti / Bridges

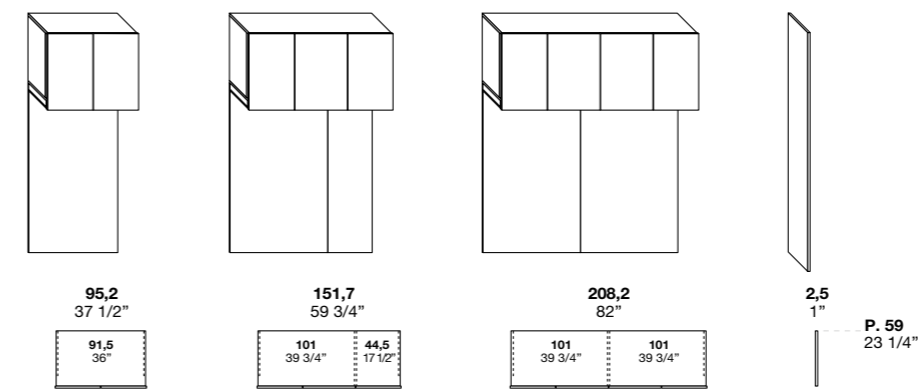

Spogliatoi / Dressing closets

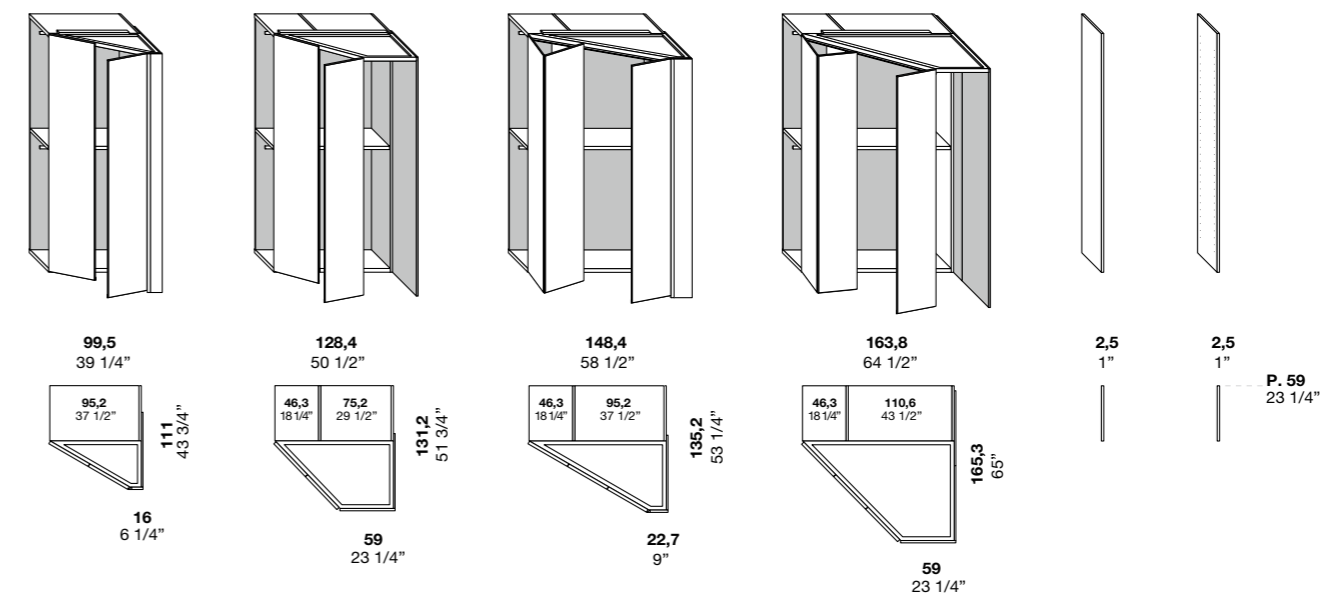

Modularità scorrevole

/Sliding modular units
 /Modularidad puerta corredera
 /Modularité coulissante
 /Module Schiebetür
 /Модульность раздвижных шкафов

Altezze / Heights

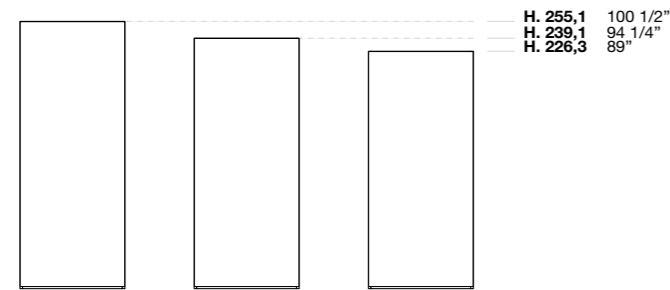

Moduli / Units

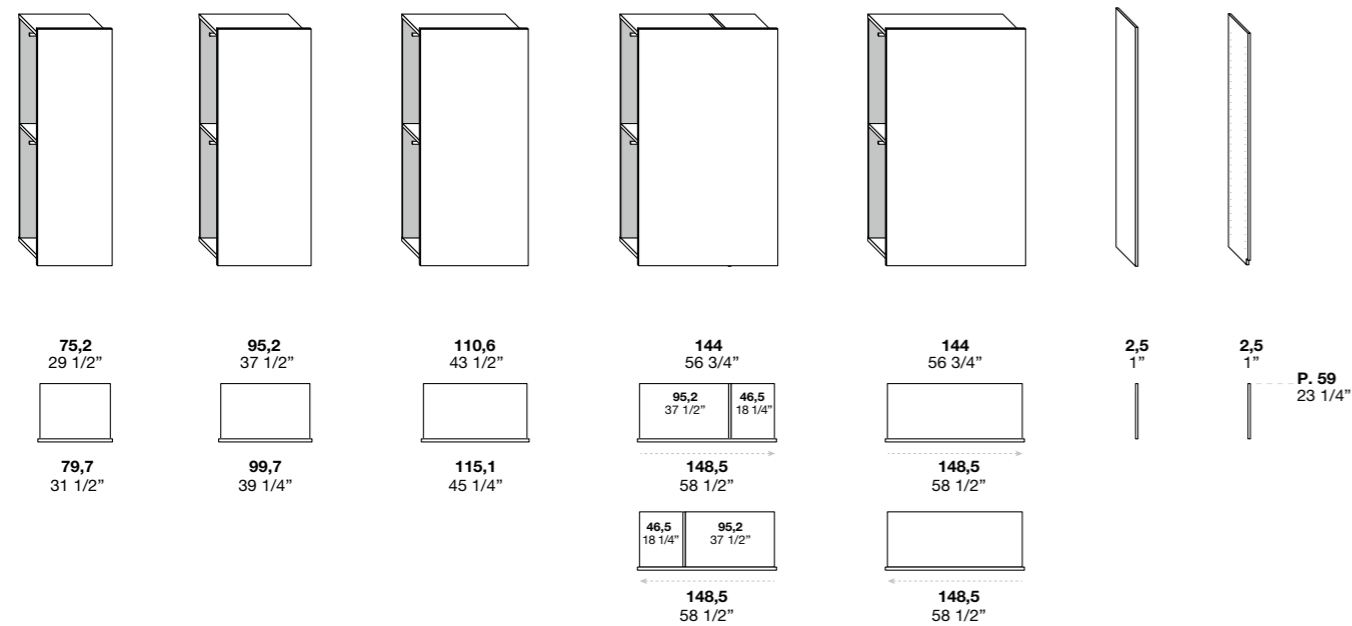

Modularità complanare

/Coplanar modular units
 /Modularidad coplanar
 /Modularité coplanaire
 /Module komplanare Türen
 /Модульность компланарных шкафов

Altezze / Heights

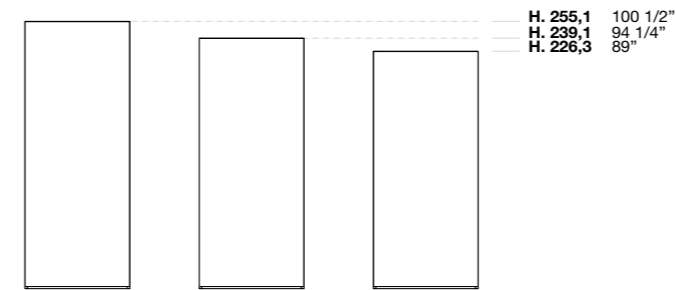

Moduli / Units

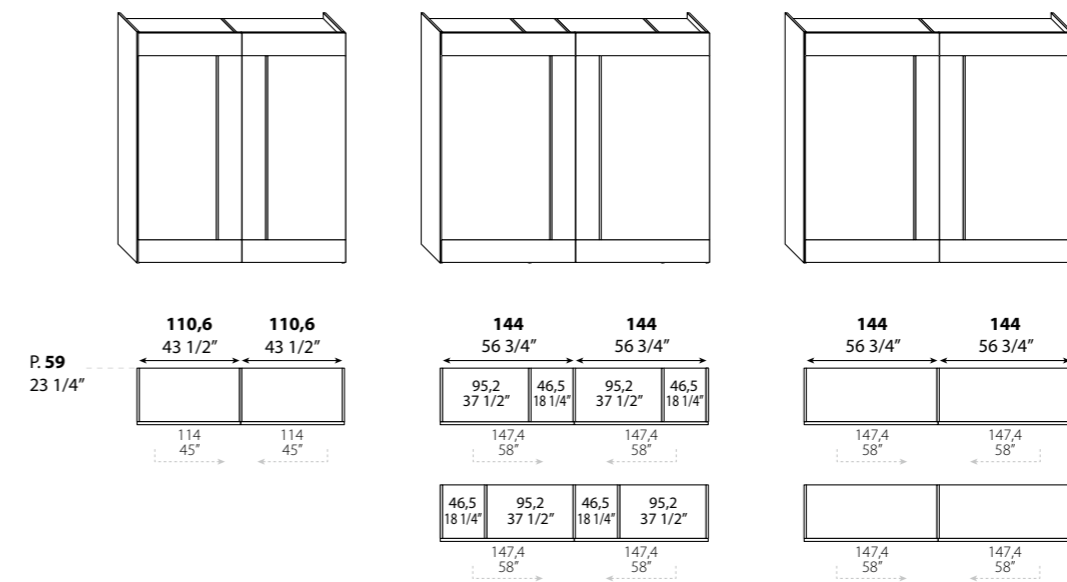

L'armadio complanare è disponibile solo in configurazione 2 ante, la configurazione 4 ante è formata dall'accostamento di 2 armadi (in tal caso si avranno 2 fianchi affiancati per l'unione dei 2 moduli)
 /The coplanar wardrobe is only available in the 2-door configuration; the 4-door configuration is created by positioning 2 wardrobes side by side (this means there are 2 side panels next to each other where the 2 units join)

Organizzazione degli interni

/Organising the inside
 /Organización de los interiores
 /Organisation des intérieurs
 /Organisation des Stauraums
 /Организация внутреннего оснащения

/technical data



1 tubo appendiabiti
 /1 clothes rail

1 cassetiera sospesa con
 vassoio estraibile H 11 cm
 /1 floating drawer-unit with
 pull-out drawer H. 11 cm

1 tubo appendiabiti
 /1 clothes rail

1 cassetiera sospesa
 con vassoio e portagonne
 estraibili H 5 cm
 /1 floating drawer-unit with
 pull-out tray and skirt rack
 H. 5 cm

1 ripiano
 /1 shelf

1 tubo appendiabiti
 /1 clothes rail
 1 cassetiera con ripiani con
 6 cassetti bassi
 frontale legno H 12,4 cm
 /1 drawer-unit with shelves
 and 6 shallow drawers,
 wood front H. 12.4 cm

4 ripiani
 /4 shelves

1 cassetiera con
 4 cassetti alti frontale legno
 H 18,8 cm
 /1 drawer-unit with
 4 deep drawers, wood front
 H. 18.8 cm

2 scatole con coperchio
 rivestite in tessuto L 40 cm
 /2 fabric-covered boxes with
 lid W. 40 m

1 ripiano
 /1 shelf

1 tubo appendiabiti
 /1 clothes rail
 1 cassetiera sospesa con
 3 vassoio bassi a giorno H
 12,4 cm
 /1 floating drawer unit with
 3 open-fronted trays, H. 12.4
 cm

2 scatole con coperchio
 rivestite in tessuto L 40 cm
 /2 fabric-covered boxes with
 lid W. 40 m

2 scatole con coperchio
 rivestite in tessuto L 40 cm
 /2 fabric-covered boxes with
 lid W. 40 m

1 ripiano
 /1 shelf

1 tubo appendiabiti
 /1 tubo appendiabiti
 1 cassetiera sospesa con
 3 vassoio bassi a giorno H
 12,4 cm
 /1 floating drawer unit with
 3 open-fronted trays, H. 12.4
 cm

2 scatole con coperchio
 rivestite in tessuto L 40 cm
 /2 fabric-covered boxes with
 lid W. 40 m

1 ripiano
 /1 shelf

1 ripiano vetro con luce
 led
 /1 glass shelf with LED light

1 raster con 3 scatole basse
 rivestite in tessuto H 8,8 cm
 /1 cubby-hole unit with 3
 shallow fabric-covered boxes
 H. 8.8 cm

1 cassetiera sospesa con
 2 vassoio bassi con frontale
 vetro H 12,4 cm
 /1 floating drawer unit with
 2 shallow trays with a glass
 front, H. 12.4 cm

1 ripiano vetro con luce led
 /1 glass shelf with LED light

3 scatole alte rivestite in
 tessuto H 15 cm
 /3 deep fabric-covered boxes
 H. 15 cm

4 ripiani
 /4 shelves

1 portascarpe
 /1 shoe rack

1 tubo appendiabiti
 /1 clothes rail
 1 raster con scatole alte
 rivestite in tessuto H 15 cm
 /1 cubby-hole unit with deep
 fabric-covered boxes H. 15
 cm

1 cassetiera con 6 cassetti
 bassi frontale legno
 H 12,4 cm
 /1 drawer unit with 6 shallow
 drawers with a wood front, H.
 12.4 cm

1 tubo appendiabiti
 /1 tubo appendiabiti

1 divisorio con ripiani e tubo
 appendiabiti
 /1 partition with shelves and
 a clothes rail

Finiture interne

/Internal finishes
/Acabados internos
/Finitions intérieures
/Innenauführungen
/Внутренняя отделка



Decor Tortora
/Tortora Decor



Decor Arena
/Arena Decor



Eukalipto Cenere
/Eukalipto Cenere



Rovere Bruno
/Bruno oak



Decor laccati opachi
/Matt lacquered Decor



Coperchio - Fondo - Fianco - Divisione
/Top - Bottom - Side - Partition



Decor Tortora
/Tortora Decor



Decor Arena
/Arena Decor

Ripiano - Schiena
/Shelf - Back panel



Decor Tortora
/Tortora Decor



Decor Arena
/Arena Decor



Eukalipto Cenere
/Eukalipto Cenere



Rovere Bruno
/Bruno oak



Decor laccati opachi
/Matt lacquered Decor



Raster - Cassettiera - Portascarpe (telaio finitura moka shine)
/Cubby-hole unit - Drawer unit - Shoe rack (Moka Shine finish on frame)

Cassettiera con vassoio estraibile (telaio finitura grigio fumo) -
Cassettiera con ripiani
/Drawer unit with pull-out tray (Grigio Fumo finish on frame)
Drawer unit with shelves

Vassoio estraibile (telaio finitura grigio fumo) -
Cassettiera con ripiani
/Pull-out tray (Grigio Fumo finish on frame) -
Drawer unit with shelves



Decor Tortora
/Tortora Decor



Decor Arena
/Arena Decor



Eukalipto Cenere
/Eukalipto Cenere



Rovere Bruno
/Bruno oak



Decor laccati opachi
/Matt lacquered Decor



Esempi di abbinamenti tra scocca, schiena e attrezzature interne

/Examples of combinations of bodies, back panels and internal fittings
 /Ejemplos de combinaciones entre estructura, trasera y equipamientos internos
 /Exemples d'associations entre structure, fond et équipements internes
 /Beispiele für die Kombination von Korpus, Rückwand und Innenausstattung
 /Примеры сочетаний каркаса, задней стенки и внутреннего оснащения



- 1 - Scocca Decor Tortora /Tortora Decor body
- 2 - Scocca Decor Arena /Arena Decor body
- 3 - Schiena Decor Tortora /Tortora Decor back panel
- 4 - Schiena Decor Arena /Arena Decor back panel
- 5 - Schiena Eukalipto Cenere /Eukalipto Cenere back panel
- 6 - Schiena Rovere Bruno /Bruno oak back panel
- 7 - Attrezzatura interna Decor Tortora /Tortora Decor internal fittings
- 8 - Attrezzatura interna Decor Arena /Attrezzatura interna Decor Arena
- 9 - Attrezzatura interna Eukalipto Cenere /Eukalipto Cenere internal fittings
- 10 - Attrezzatura interna Rovere Bruno /Bruno oak internal fittings

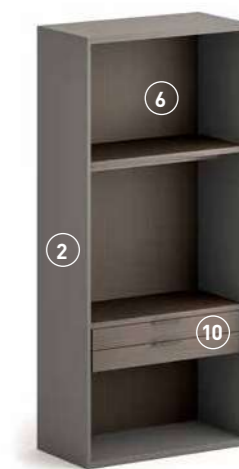
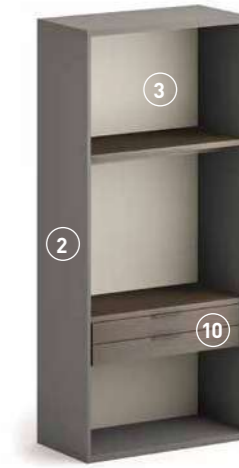
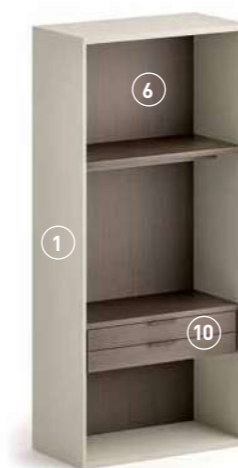

Disponibile anche in Decor laccati opachi /Also available in matt lacquered Decor

Dettagli

/Details
/Detalles
/Détails
/Details
/Детали



Tappino in tinta per decor Tortora
/Plugs to match Tortora Decor

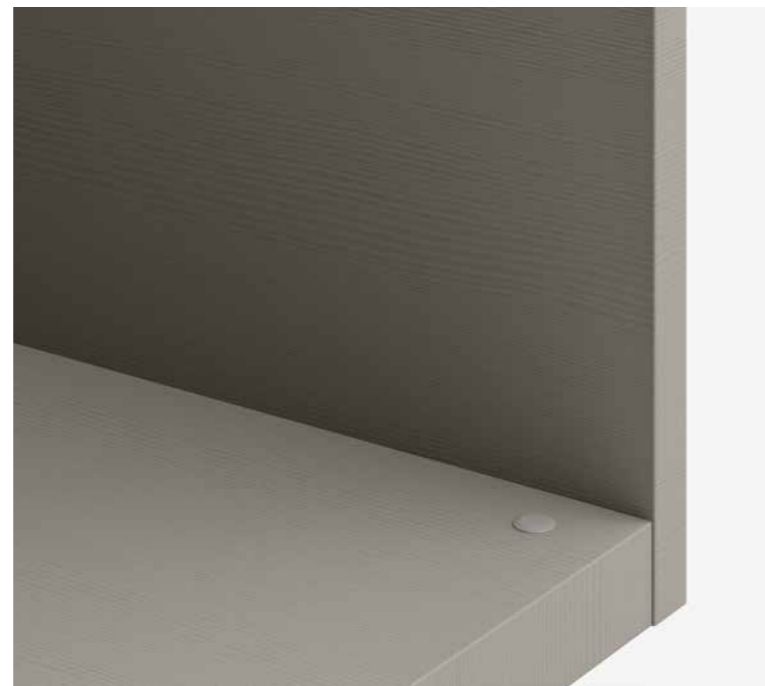

Tappino in tinta per decor Arena
/Plugs to match Arena Decor



Cerniera
/Hinge



Cerniera a perno per anta Display in finitura verniciato Moka shine
/Pin hinge for Display door in painted Moka Shine finish

Illuminazione

/Lighting
/Iluminación
/Éclairage
/Beleuchtung
/Подсветка



Barra luce led in alluminio finitura Moka Shine per coperchio
/Aluminium LED strip in Moka Shine finish for top



Barra luce led incassata per fianco o divisione
/Built-in LED strip for side panels or partitions



Ripiano vetro trasparente grigio con telaio alluminio finitura grigio fumo con luce led
/Grigio transparent glass shelf with aluminium frame in Grigio Fumo finish with LED light

Ripiani

/Shelves
/Baldas
/Étagères
/Fachböden
/Полки

/technical data



Tipologie ripiani

/Types of shelving
/Tipos de baldas
/Typologies d'étagères
/Typologie Fachböden
/Варианты полок

Ripiano
/Shelf



Ripiano vetro trasparente grigio con telaio alluminio
finitura grigio fumo
/Grigio transparent glass shelf with aluminium
frame, Grigio Fumo finish



Ripiano vetro trasparente grigio con telaio alluminio
finitura grigio fumo con luce led
/Grigio transparent glass shelf with aluminium
frame in Grigio Fumo finish with LED light



Tipologie coperchi

/Types of tops
/Tipos de tapas
/Typologies de dessus
/Typologie Deckelböden
/Варианты верхних панелей

Coperchio
/Top



Coperchio portaoggetti
/Storage unit top



Entrambi disponibili per:
- cassettiere
- vassoi estraibili
- cassettiere con ripiani
/Both available for:
- drawer units
- pull-out trays
- drawer units with shelves

Tipologie cassetti e vassoi

/Types of drawers and trays
/Tipos de cajones y bandejas
/Typologies de tiroirs et plateaux
/Typologie Schubladen und Ablagen
/Варианты ящиков и лотков

Cassetto alto con frontale in legno H 18,8 cm
/Deep drawer with wood front, H. 18.8 cm



Vassoio alto con frontale vetro trasparente grigio H 18,8 cm
/Deep tray with Grigio transparent glass front, H. 18.8 cm



Vassoio alto a giorno H 18,8 cm
/Open-fronted deep tray, H. 18.8 cm



Cassetto basso con frontale in legno H 12,4 cm
/Shallow drawer with wood front, H. 12.4 cm



Vassoio basso con frontale vetro trasparente grigio H 12,4 cm
/Shallow tray with Grigio transparent glass front, H. 12.4 cm



Vassoio basso a giorno H 12,4 cm
/Open-fronted shallow tray, H. 12.4 cm



I cassetti e i vassoi sono dotati di guide con chiusura assistita.
/The drawers and trays are fitted with assisted-closing runners.

Finiture cassetti / vassoi con frontale vetro / vassoi a giorno

/Finishes for drawers/trays with a glass front/open-fronted trays
 /Acabados de cajones / bandejas con frontal de cristal / bandejas abiertas
 /Finitions des tiroirs / plateaux avec façade en verre / plateaux ouverts
 /Ausführungen Schubladen / Ablagen mit Glasfront / offene Ablagen
 /Отделка ящиков / лотков с передней стеклянной панелью / открытых лотков



Cassetto con frontale in legno e interno in polimerico
 /Drawer with wooden front and polymer inside



Vassoio con frontale in vetro trasparente grigio
 /Tray with Grigio transparent glass front



Vassoio a giorno
 /Open-fronted tray



Decor Tortora
 /Tortora Decor

Decor Arena
 /Arena Decor

Eukalipto Cenere
 /Eukalipto Cenere

Rovere Bruno
 /Bruno oak

Decor laccati opachi
 /Matt lacquered Decor

Finiture vassoi estraibili con telaio alluminio

/Finishes for pull-out trays with an aluminium frame
 /Acabados de bandejas extraíbles con estructura de aluminio
 /Finitions de plateaux extractibles avec cadre en aluminium
 /Ausführungen ausziehbare Ablagen mit Aluminiumrahmen
 /Отделка выдвигающих лотков с алюминиевой рамкой

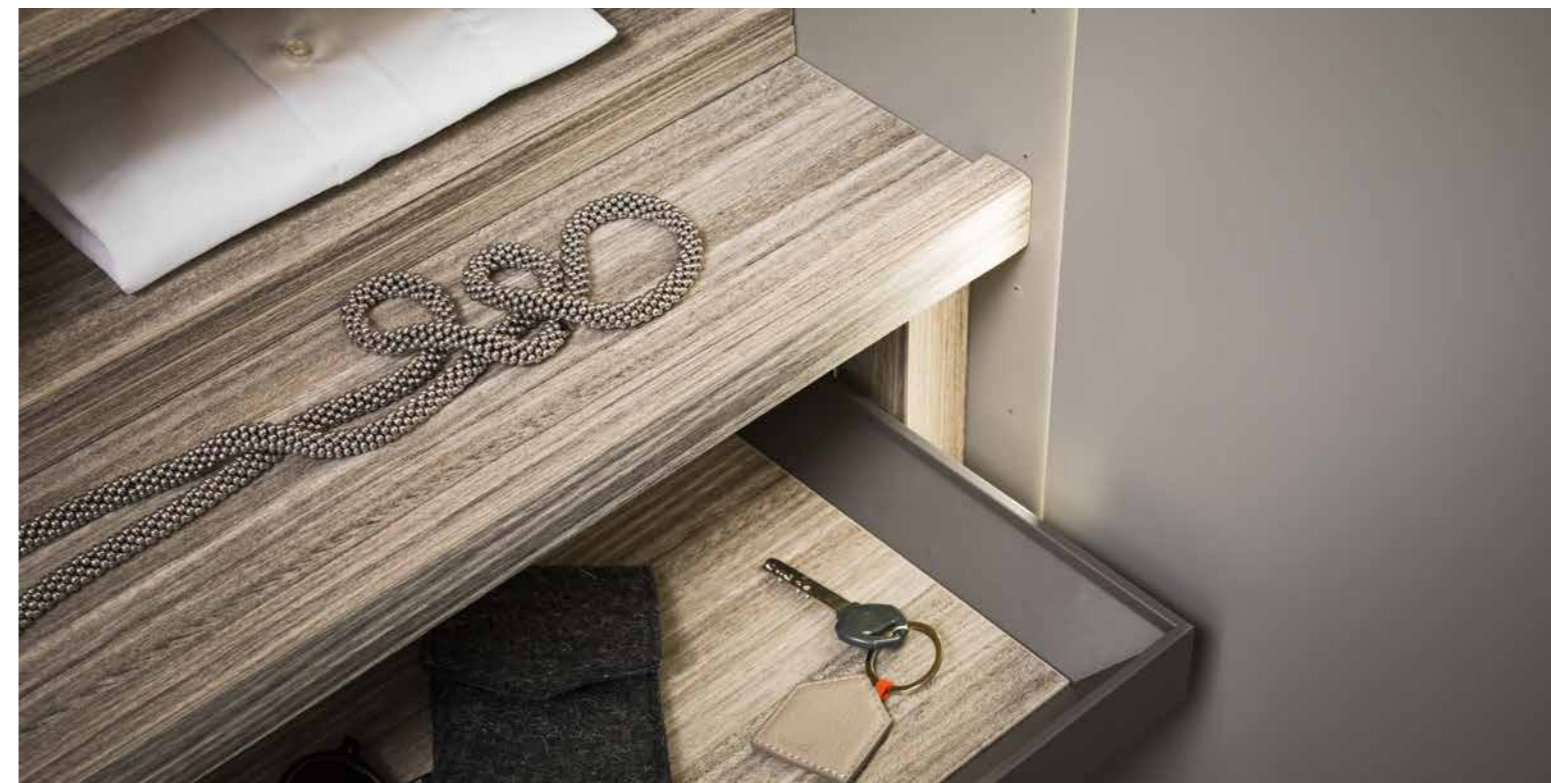

Vassoio in alluminio grigio fumo con fondo in
 finitura H 5 cm
 /Grigio Fumo aluminium tray with finished bottom
 H. 5 cm



Vassoio in alluminio grigio fumo con fondo in
 finitura H 11 cm
 /Grigio Fumo aluminium tray with finished bottom
 H. 11 cm



Decor Tortora
 /Tortora Decor

Decor Arena
 /Arena Decor

Eukalipto Cenere
 /Eukalipto Cenere

Rovere Bruno
 /Bruno oak

Decor laccati opachi
 /Matt lacquered Decor

Accessori per cassetti e vassoi

/Accessories for drawers and trays
 /Accesorios para cajones y bandejas
 /Accessoires pour tiroirs et plateaux
 /Zubehör für Schubladen und Ablagen
 /Дополнительные элементы для ящиков и лотков

Scatole portaoggetti rivestite in tessuto H 5 cm
 /Fabric-covered storage boxes H. 5 cm



20

10

Scatole portaoggetti per cassetto rivestite in tessuto
 /Fabric-covered storage boxes for drawers



Scatole portaoggetti per vassoio estraibile rivestite in tessuto
 /Fabric-covered storage boxes for pull-out trays



Proposte accessori per cassetti e vassoi

/Examples of accessories for drawers and trays
 /Propuestas de accesorios para cajones y bandejas
 /Propositions d'accessoires pour tiroirs et plateaux
 /Beispiele Zubehör für Schubladen und Ablagen
 /Предложения дополнительных элементов для ящиков и лотков



Cassetto con profondità interna 40,7 cm
 /Drawer unit, internal depth 40.7 cm



Vassoio estraibile con profondità interna 38,5 cm
 /Pull-out tray, internal depth 38.5 cm

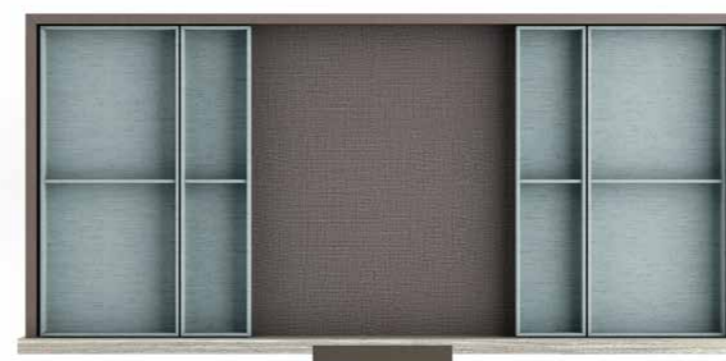

Cassetto con profondità interna 40,7 cm
 /Drawer unit, internal depth 40.7 cm



Vassoio estraibile con profondità interna 38,5 cm
 /Pull-out tray, internal depth 38.5 cm



Cassetto con profondità interna 40,7 cm
 /Drawer unit, internal depth 40.7 cm



Vassoio estraibile con profondità interna 38,5 cm
 /Pull-out tray, internal depth 38.5 cm

Elementi sospesi e soluzione portascarpe

/Floating units and shoe-rack solutions
 /Elementos suspendidos y zapatero
 /Éléments suspendus et solution porte-chaussures
 /Hängeelemente und Lösungen für Schuhablagen
 /Навесные элементы и подставки для обуви



Portapantaloni in alluminio finitura grigio fumo H 5 cm
 /Aluminium trouser rack in Grigio Fumo finish, H. 5 cm



Portagonna in alluminio finitura grigio fumo H 5 cm
 /Aluminium skirt rack in Grigio Fumo finish, H. 5 cm



Portascarpe in Moka Shine e fondi in finitura
 /Shoe rack in Moka Shine with finished bottom

Raster

/Cubby-hole unit
 /Raster
 /Raster
 /Raster
 /Растровые конструкции



Raster
 /Cubby-hole unit



Raster con scatole rivestite in tessuto
 /Cubby-hole unit with fabric-covered boxes

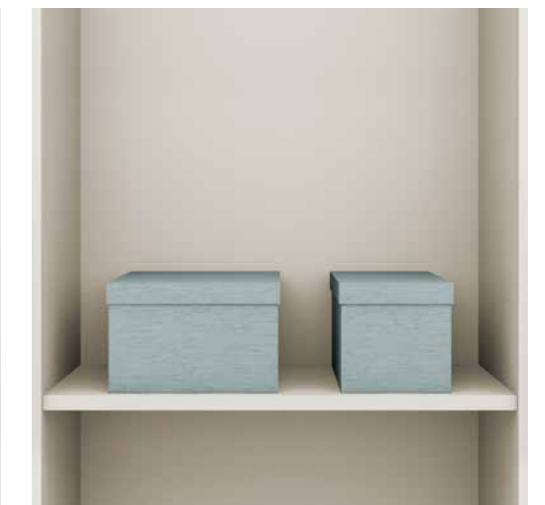

Scatole con coperchio rivestite in tessuto
 /Fabric-covered boxes with lid

* Le scatole rivestite in tessuto nei Raster possono essere posizionate solo nei vani centrali
 /The fabric-covered boxes in the cubby-hole units can only be used in the central compartments

Appenderia

/Hanging rails
/Colgador
/Penderie
/Kleiderbügel
/Вешалки



Gruccia con portapantaloni L. 44 cm in legno Wenghé
/Hanger with trouser rack L. 44 cm in Wenge wood



Anello portasciarpe Ø 15 cm in legno Wenghé
/Scarf storage loop, Ø 15 cm, in Wenge wood



Tubo appendiabiti Moka Shine
/Moka Shine clothes rail



Tubo appendiabiti opzionale Moka Shine con guarnizione
/Optional Moka Shine clothes rack with seal



Forcella appendiabiti finitura Brown
/High-reach clothes hook, Brown finish



Servetto oleodinamico finitura Brown
/Pull-down rail, Brown finish

Specchi interni

/Internal mirrors
/Espejos internos
/Miroirs internes
/Innenspiegel
/Внутренние зеркала

Specchio interno fisso per anta battente
/Fixed internal mirror for swinging door



Isola cassetti esterna

/External drawer-unit island
/Isla externa con cajones
/Îlot tiroirs externe
/Insel mit externen Schubladen
/Внешняя островная конструкция с ящиками



Isola cassetti esterna L 110,7 cm
/External drawer-unit island W 110.7 cm

Isola cassetti esterna L 146,9 cm
/External drawer-unit island W 146.9 cm



Isola cassetti esterna L 186,9 cm
/External drawer-unit island W 186.9 cm

Le isole cassetti esterne sono formate da:
1 vassoio basso con frontale vetro trasparente grigio H 12,4 cm
1 vassoio alto con frontale vetro trasparente grigio H 18,8 cm
2 cassetti alto con frontale legno H 18,8 cm
maniglie finitura Moka shine
retro a giorno
/The external drawer-unit islands are composed of:
1 shallow tray with Grigio transparent glass front, H. 12.4 cm
1 deep tray with Grigio transparent glass front, H. 18.8 cm
2 deep drawers with wood front H. 18.8 cm
handles in Moka Shine finish
open back

Moduli

/Units
/Módulos
/Modules
/Module
/Модули

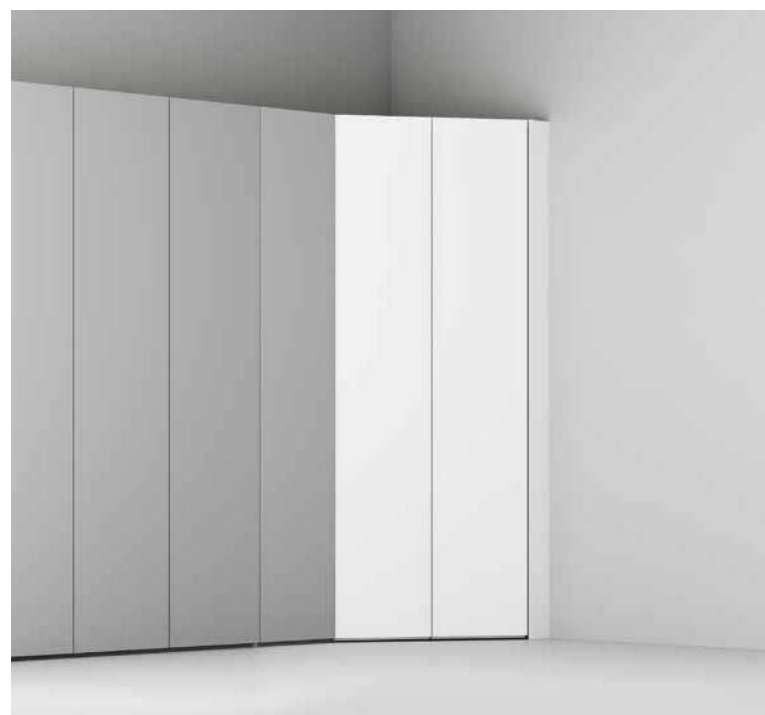

Spogliatoio 2 ante
/2-door dressing closet

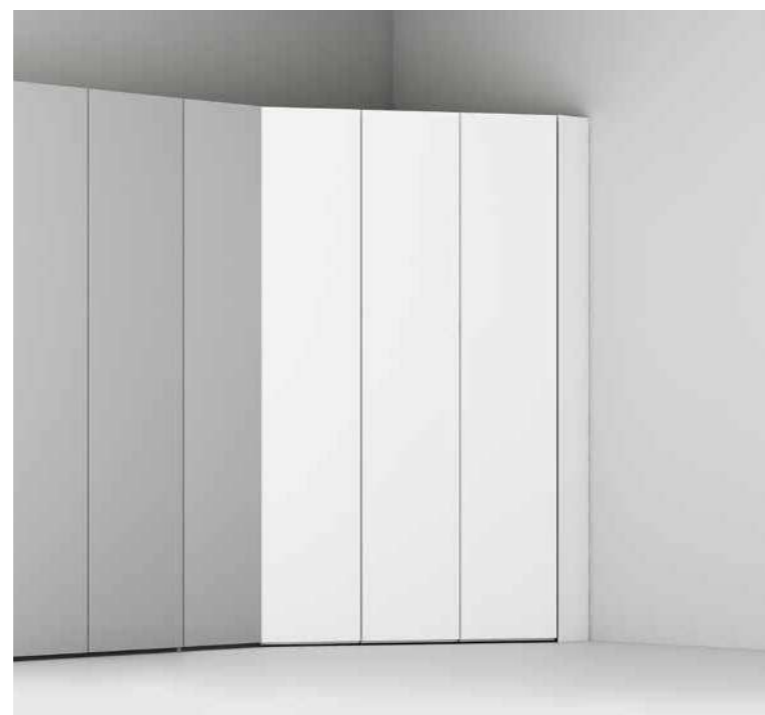

Spogliatoio 3 ante
/3-door dressing closet

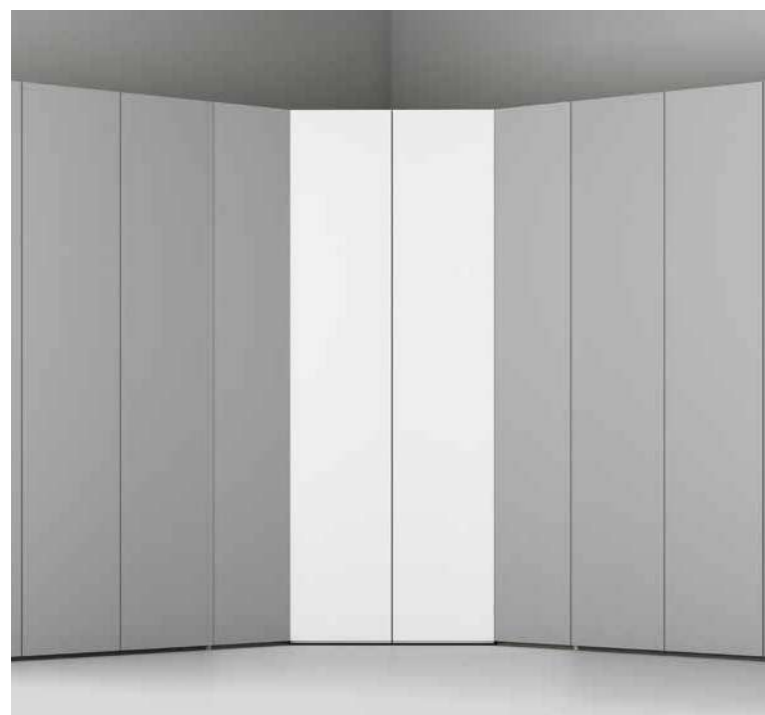

Angolo spogliatoio 2 ante
/2-door corner dressing closet

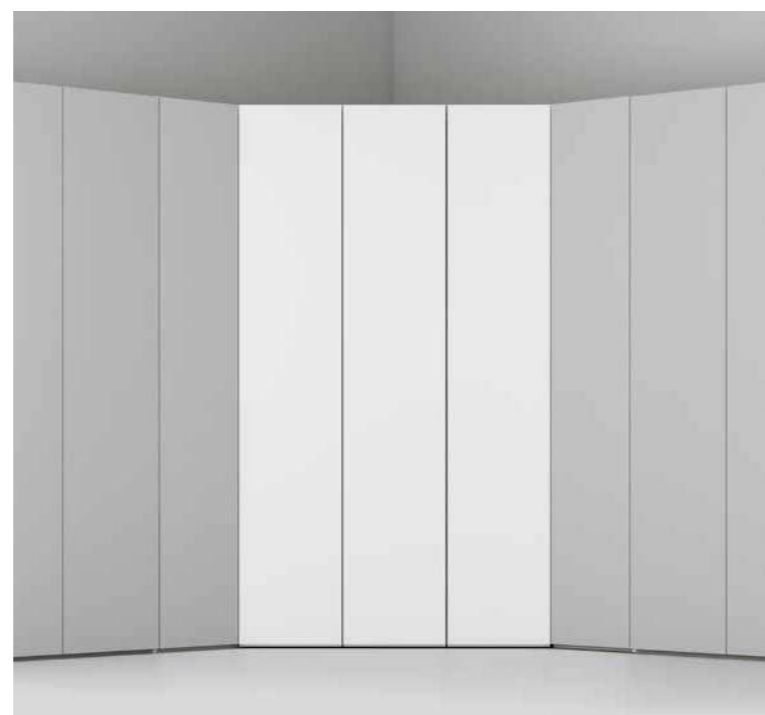

Angolo spogliatoio 3 ante
/3-door corner dressing closet



Vano a giorno
/Open compartment

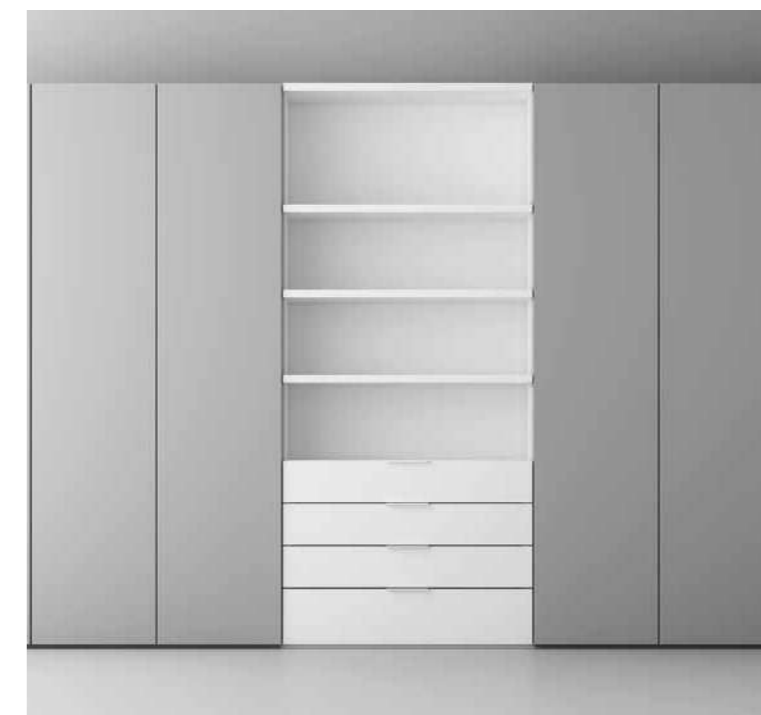

Vano a giorno con cassetiera
/Open-fronted compartment with drawer unit

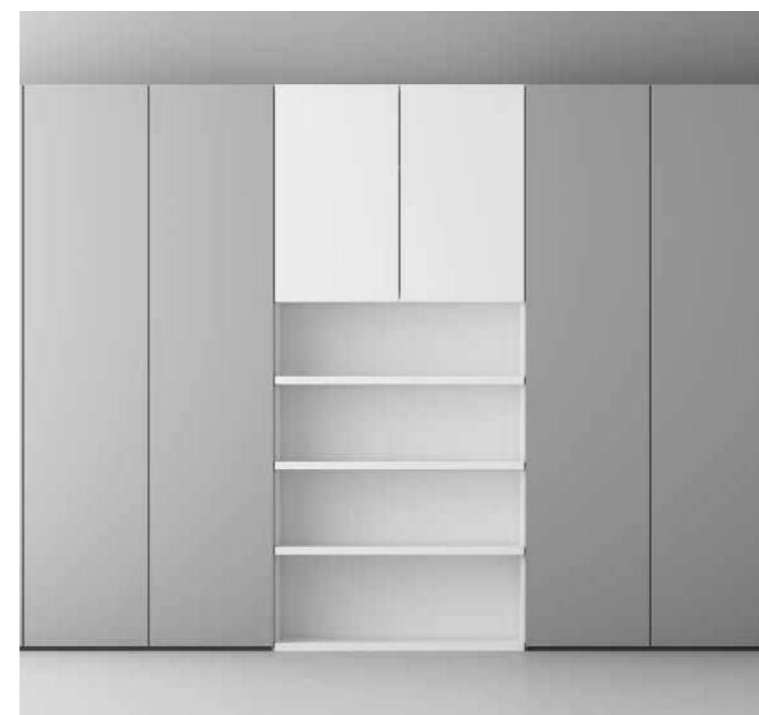

Vano a giorno con anta
/Open-fronted compartment with door

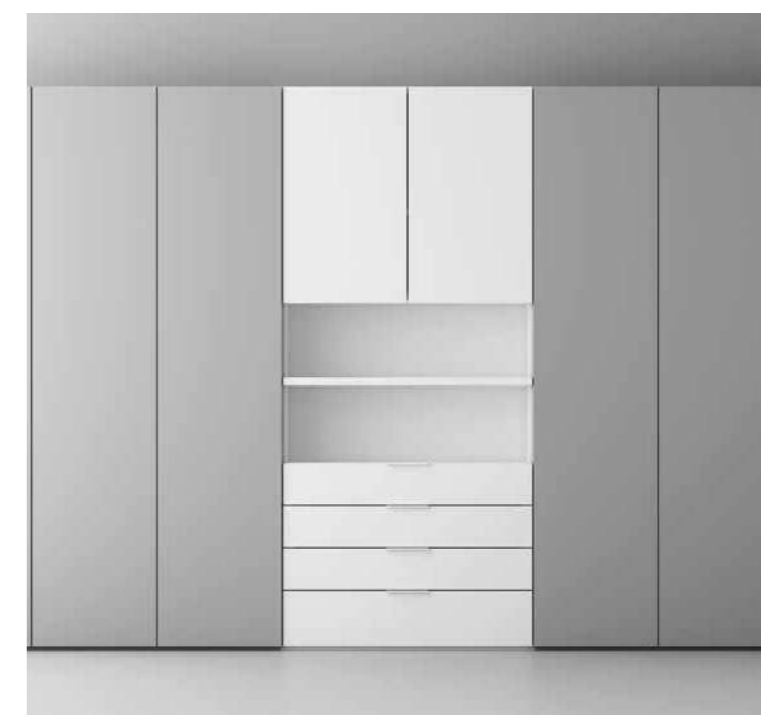

Vano a giorno con cassetiera e anta
/Open-fronted compartment with drawer unit and door

Moduli

/Units
/Módulos
/Modules
/Module
/Модули



Anta battente
/Swinging door



Anta scorrevole
/Sliding door



Anta complanare
/Coplanar door

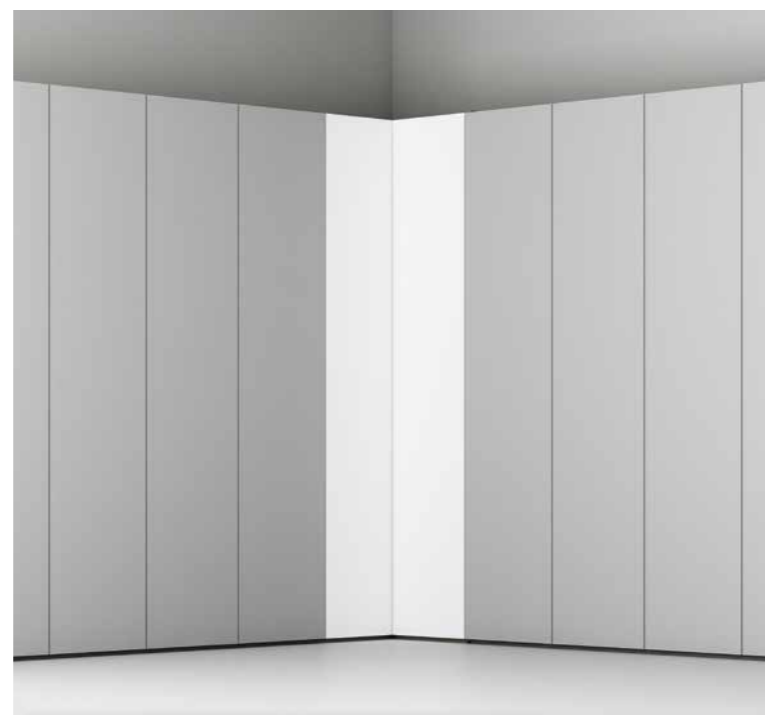

Angolo
/Corner

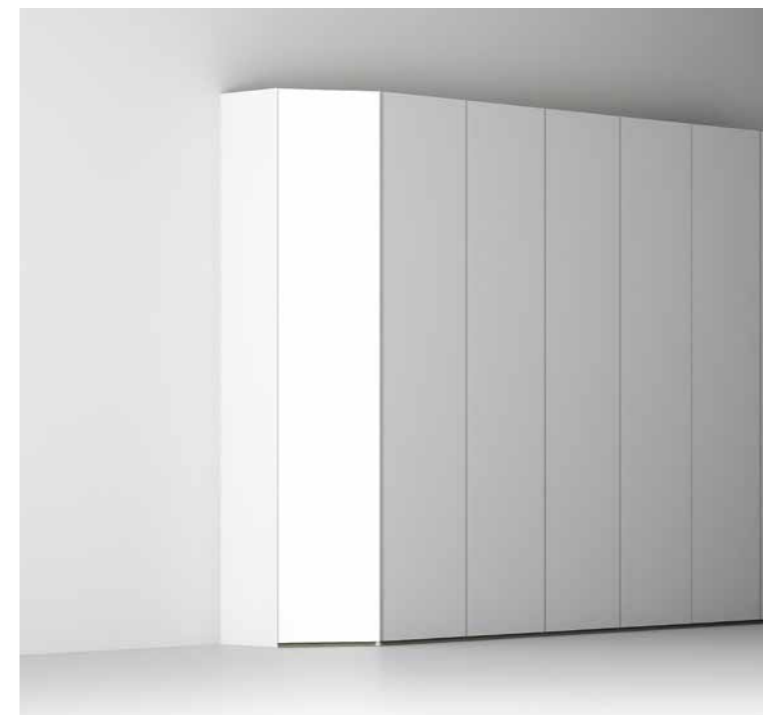

Terminale
/End unit



Ponte 2 ante
/2-door bridge



Ponte 3 ante
/3-door bridge



Ponte 4 ante
/4-door bridge

Moduli

/Units
/Módulos
/Modules
/Module
/Модули

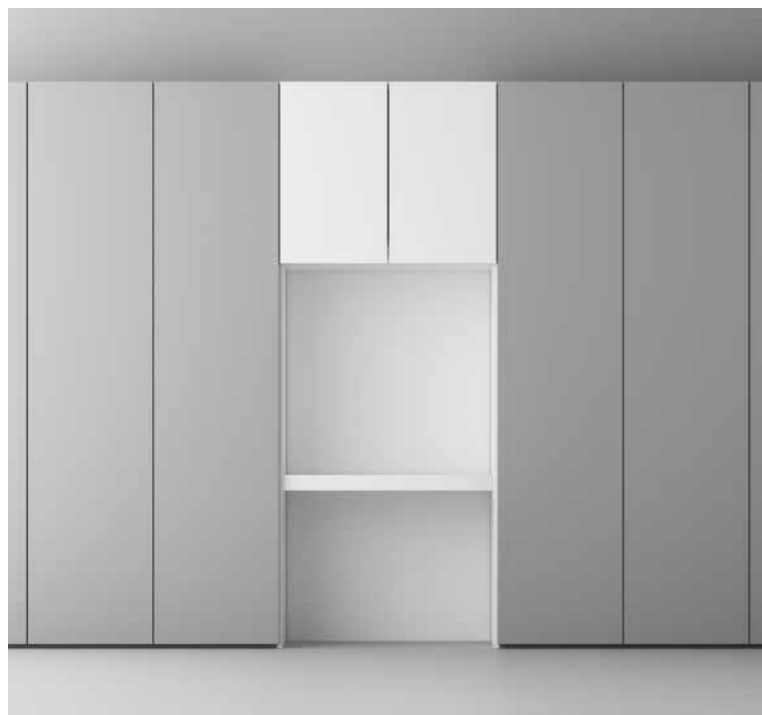

Ponte due ante con scrittoio
/2-door bridge with desk

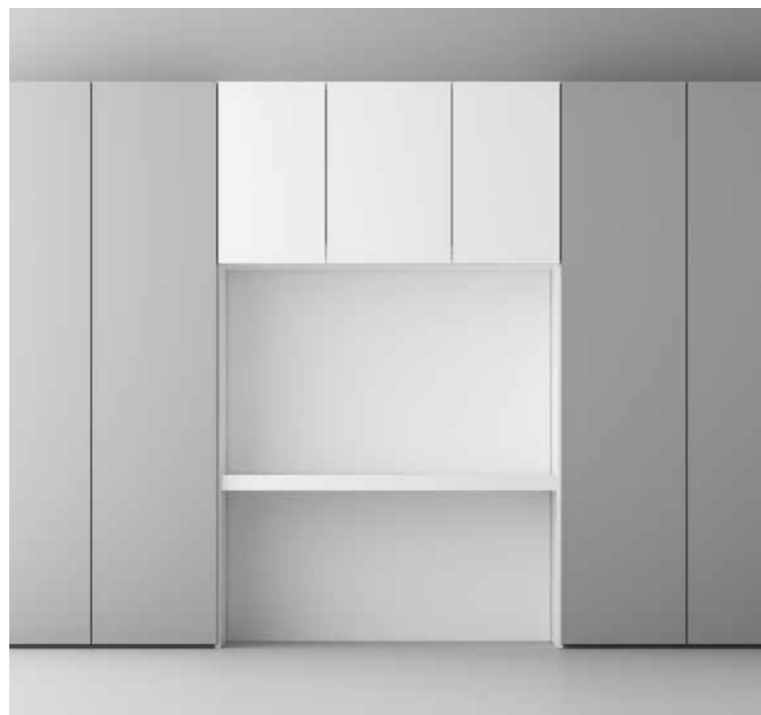

Ponte tre ante con scrittoio
/3-door bridge with desk



Ponte quattro ante con scrittoio
/4-door bridge with desk

Vetri serigrafati anta Frame

/Silk-screen printed glass, Frame door
/Cristales serigrafiados puerta Frame
/Verres sérigraphiés des portes Frame
/Glas mit Siebdruck Tür Frame
/Шелкотрафаретные стекла для створки Frame

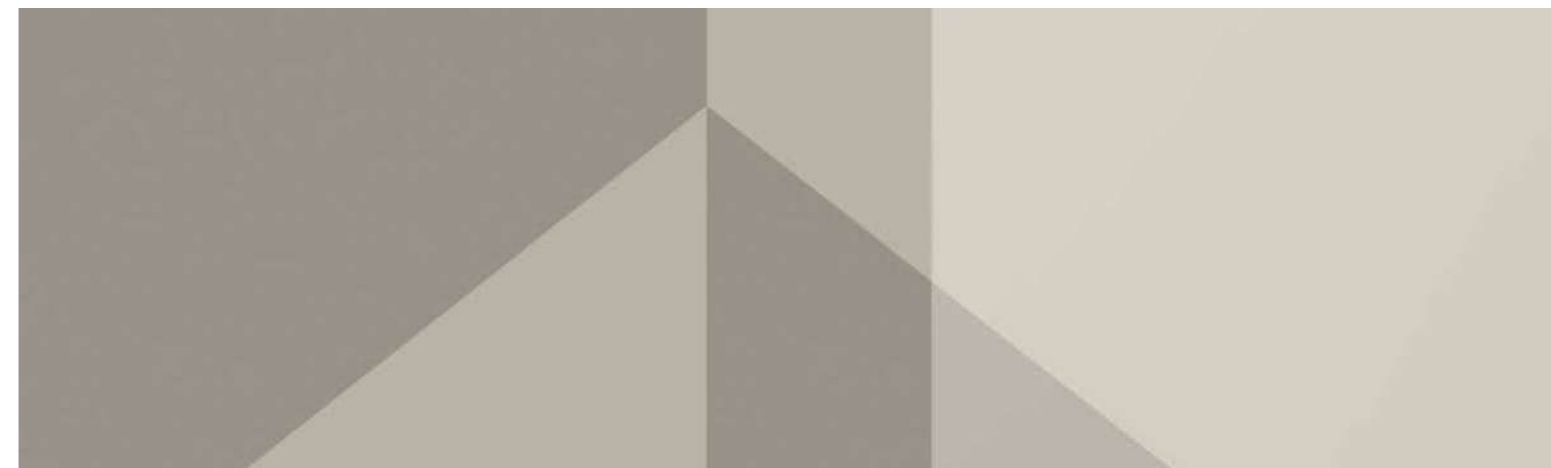

Vetro lucido serigrafato **Sari** /Sari high-gloss silk-screened glass

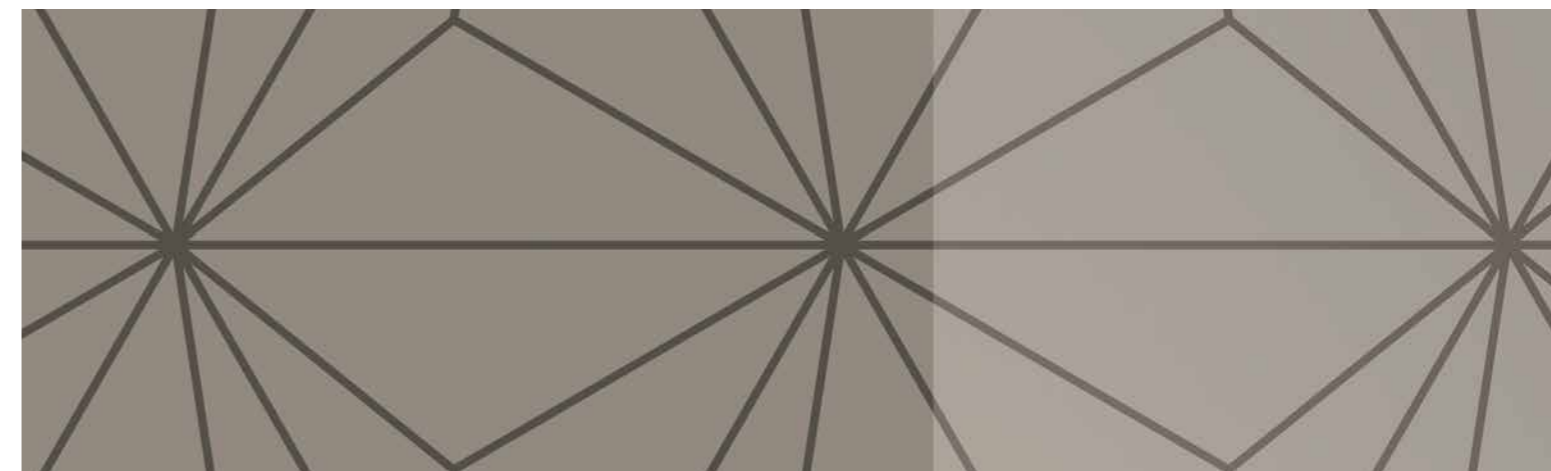

Vetro lucido serigrafato **Asà** /Asà high-gloss silk-screened glass

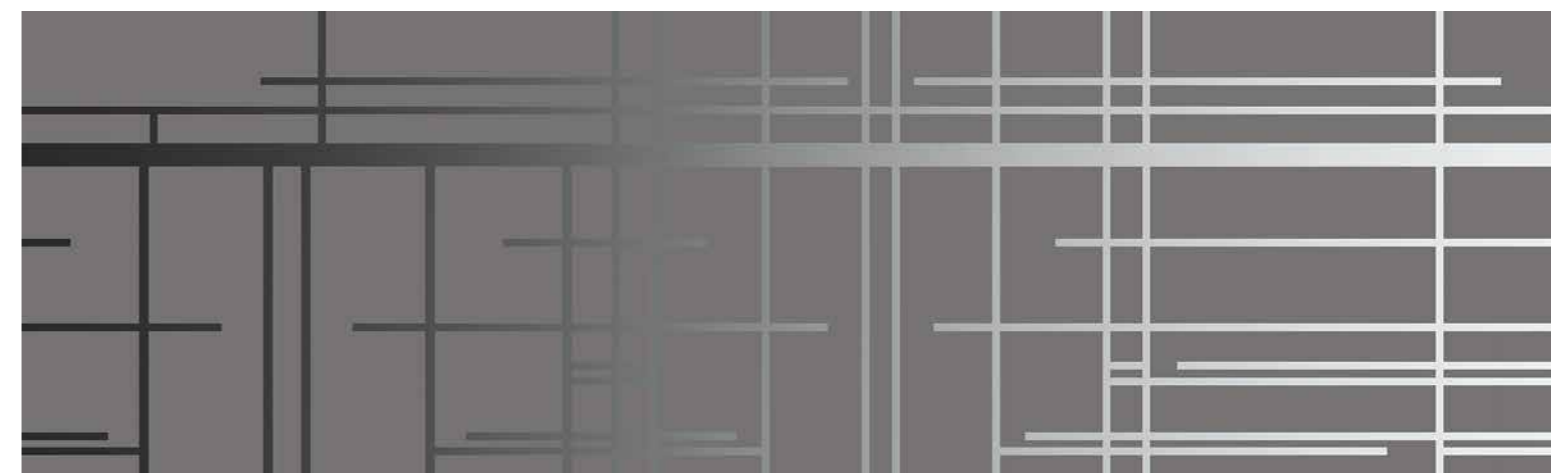

Specchio grigio con serigrafia **Grigio Lino** /Grigio mirror with **Grigio Lino** silk-screen printing

